

LAH15BN NSK

Linear guides

TYPE: Monorail guidance systems, Recirculating balls, High vertical load carrying capacity type, Self-aligning type, Square type, High, Ball slide length - long, Mounting tap, Interchangeable part

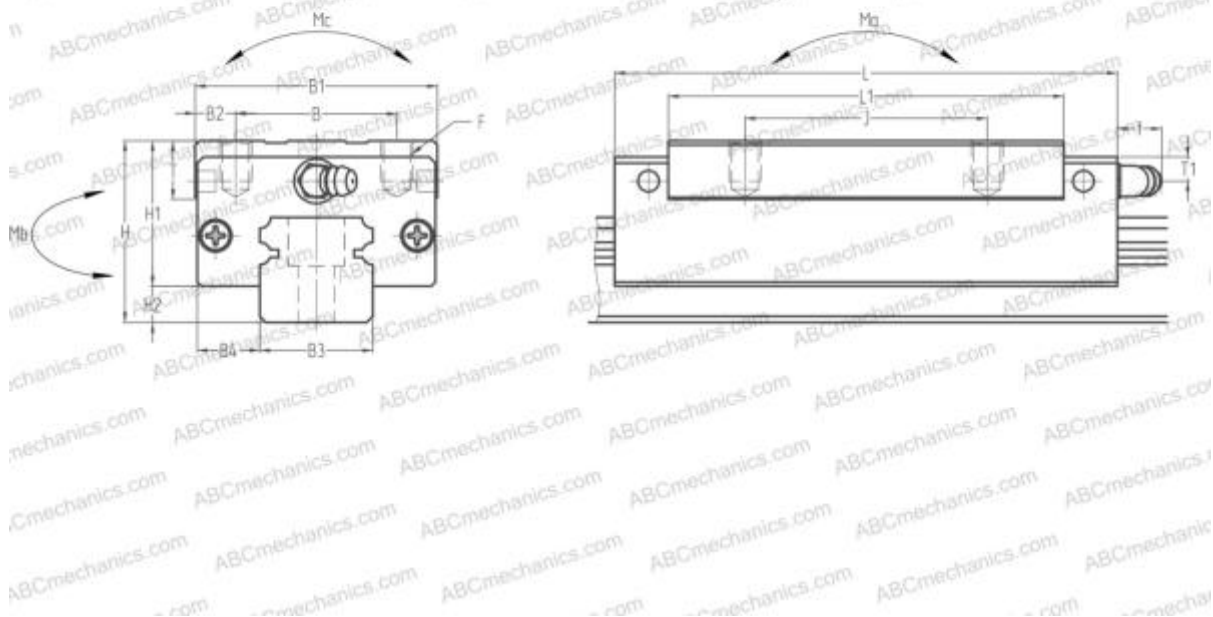

Technical specification

DIMENSIONS, MM

B1	34,000
H	28,000
L	55,000
B	26,000
J	26,000
L1	39,000
B2	4,000
B3	15,000
B4	9,500
H1	23,400
H2	4,600
T	8,000
T1	8,500
f	3,300
F	M4x0.7x6

SLIDE WEIGHT

0,180

MANUFACTURER

[NSK](#)

CALCULATION DATA

Basic dynamic load rating, C	10,800 kN
Basic static load rating, Co	20,700 kN
Static permissible moment, Ma	0,095 kN-m
Static permissible moment, Mb	0,080 kN-m
Static permissible moment, Mc	0,108 kN-m