

## LAH20BN NSK

Linear guides

TYPE: Monorail guidance systems, Recirculating balls, High vertical load carrying capacity type, Self-aligning type, Square type, High, Ball slide length - long, Mounting tap, Interchangeable part

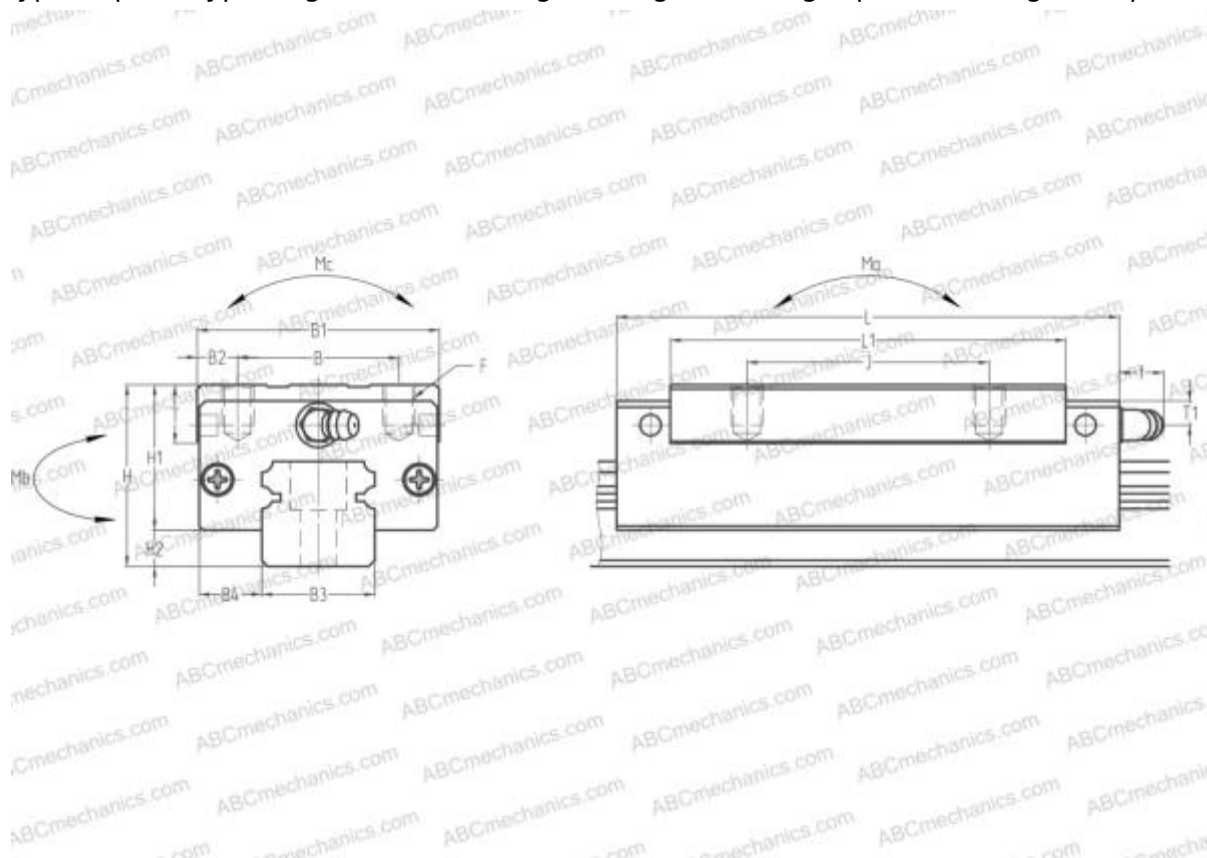

### Technical specification

#### DIMENSIONS, MM

B1	44,000
H	30,000
L	91,800
B	32,000
J	50,000
L1	72,000
B2	6,000
B3	20,000
B4	12,000
H1	25,000
H2	5,000
T	12,000
T1	5,000
f	11,000
F	M5x0.8x6

#### SLIDE WEIGHT

0,480

#### MANUFACTURER

[NSK](#)

#### CALCULATION DATA

Basic dynamic load rating, C	18,200 kN
Basic static load rating, Co	39,500 kN
Static permissible moment, Ma	0,345 kN-m
Static permissible moment, Mb	0,345 kN-m
Static permissible moment, Mc	0,305 kN-m