

LAH25BN NSK

Linear guides

TYPE: Monorail guidance systems, Recirculating balls, High vertical load carrying capacity type, Self-aligning type, Square type, High, Ball slide length - long, Mounting tap, Interchangeable part

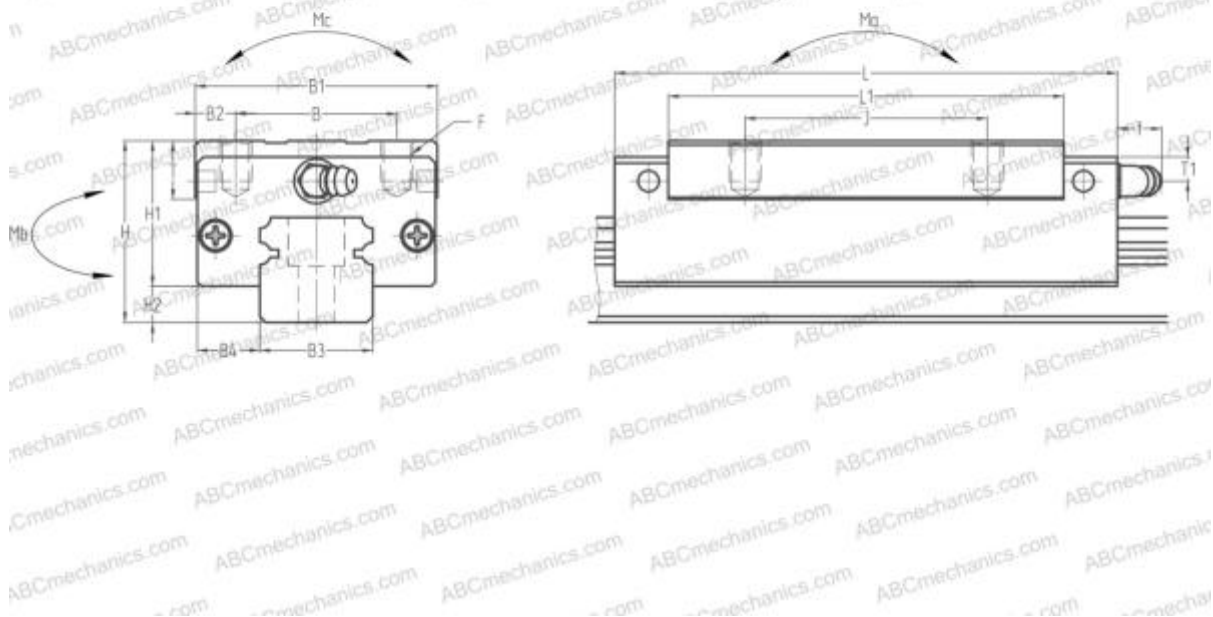

Technical specification

DIMENSIONS, MM

B1	48,000
H	40,000
L	107,000
B	35,000
J	50,000
L1	86,000
B2	6,500
B3	23,000
B4	12,500
H1	33,000
H2	7,000
T	12,000
T1	10,000
f	11,000
F	M6x1x9

SLIDE WEIGHT

0,820

MANUFACTURER

[NSK](#)

CALCULATION DATA

Basic dynamic load rating, C	26,900 kN
Basic static load rating, Co	52,500 kN
Static permissible moment, Ma	0,530 kN-m
Static permissible moment, Mb	0,520 kN-m
Static permissible moment, Mc	0,470 kN-m