

LAH45BN NSK

Linear guides

TYPE: Monorail guidance systems, Recirculating balls, High vertical load carrying capacity type, Self-aligning type, Square type, High, Ball slide length - long, Mounting tap, Interchangeable part

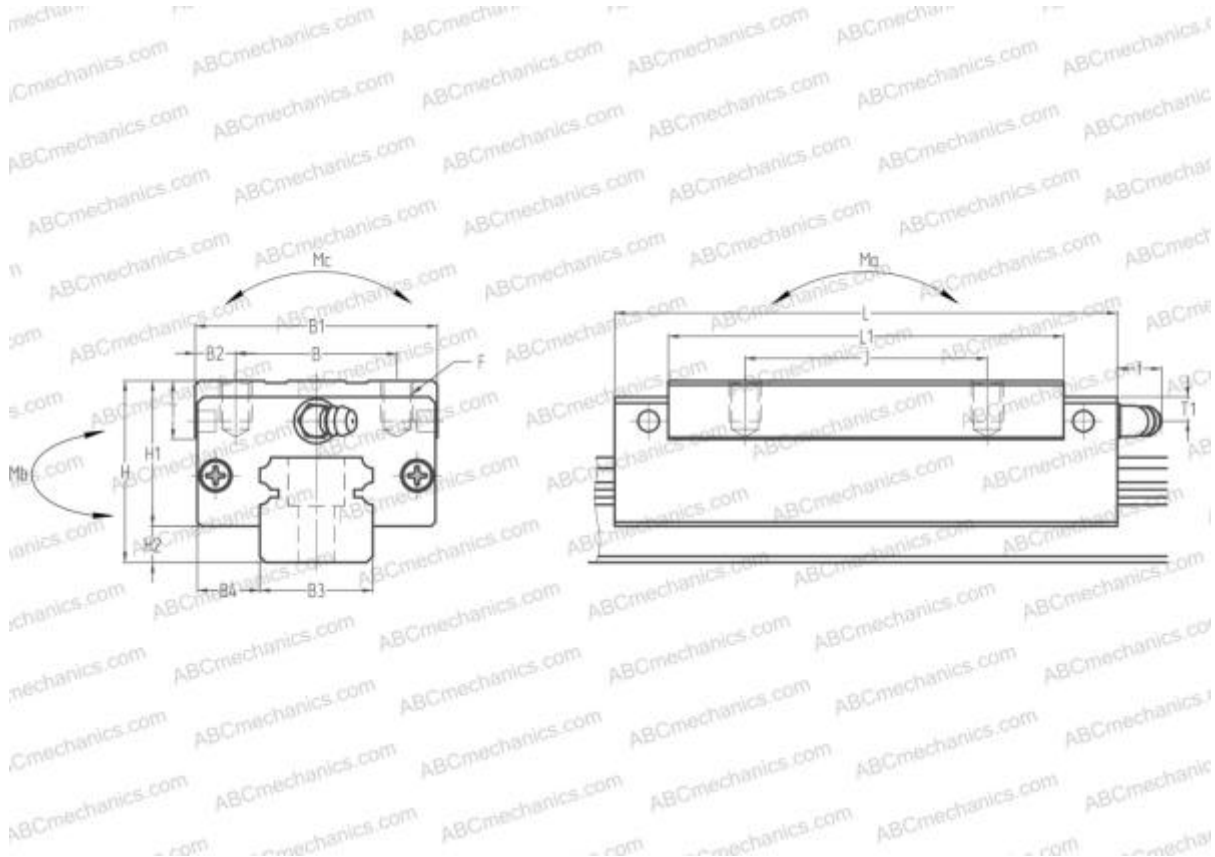

Technical specification

DIMENSIONS, MM

B1	86,000
H	70,000
L	171,000
B	60,000
J	80,000
L1	137,000
B2	13,000
B3	45,000
B4	20,500
H1	56,000
H2	14,000
T	17,000
T1	20,000
f	13,000
F	M10x1.5x17

SLIDE WEIGHT

3,900

MANUFACTURER

[NSK](#)

CALCULATION DATA

Basic dynamic load rating, C	79,500 kN
Basic static load rating, Co	146,000 kN
Static permissible moment, Ma	2,460 kN-m
Static permissible moment, Mb	2,430 kN-m
Static permissible moment, Mc	2,590 kN-m