

LWESC20 IKO

Linear guides

TYPE: Monorail guidance systems, Recirculating balls, High vertical load carrying capacity type, Self-aligning type, Square type, Low, Ball slide length - short, Mounting tap

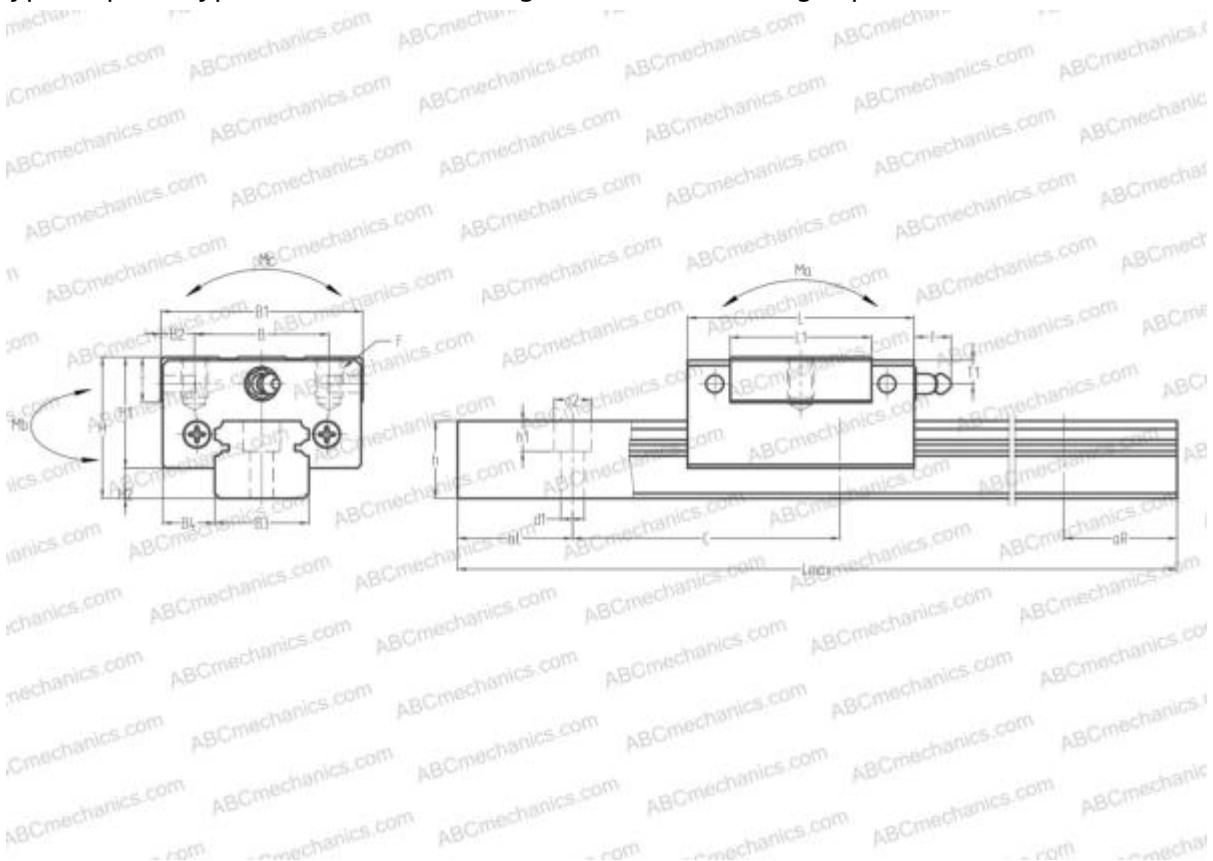

Technical specification

DIMENSIONS, MM

B1	42,000
H	28,000
L	47,200
B	32,000
L1	30,000
B2	5,000
B3	20,000
B4	11,000
H1	22,000
H2	6,000
T	12,000
T1	5,500
f	11,000
C	60,000
d1	6,000

DIMENSIONS, MM

d2	9,500
h	15,500
h1	8,500
L max	3960,000
aL	20,000
aR	20,000
F	M5x0.8x7

WEIGHT

Slide weight	0,190
Rail weight	2,300

MANUFACTURER

[IKO](#)

INTERCHANGE

ABC	LS20CL
NSK	LS20CL
THK	SR20V

INTERCHANGE

HIWIN	EGH20SA
STAR	1664-8
Rockford Linear Motion	RPG20SV
INA	KUV20-B-ESC
NB	SGL20F