

SAH15AN NSK

Linear guides

TYPE: Monorail guidance systems, Recirculating balls, High vertical load carrying capacity type, Self-aligning type, Square type, High, Ball slide length - standard, Mounting tap, Low noise, smooth operation type, Interchangeable part

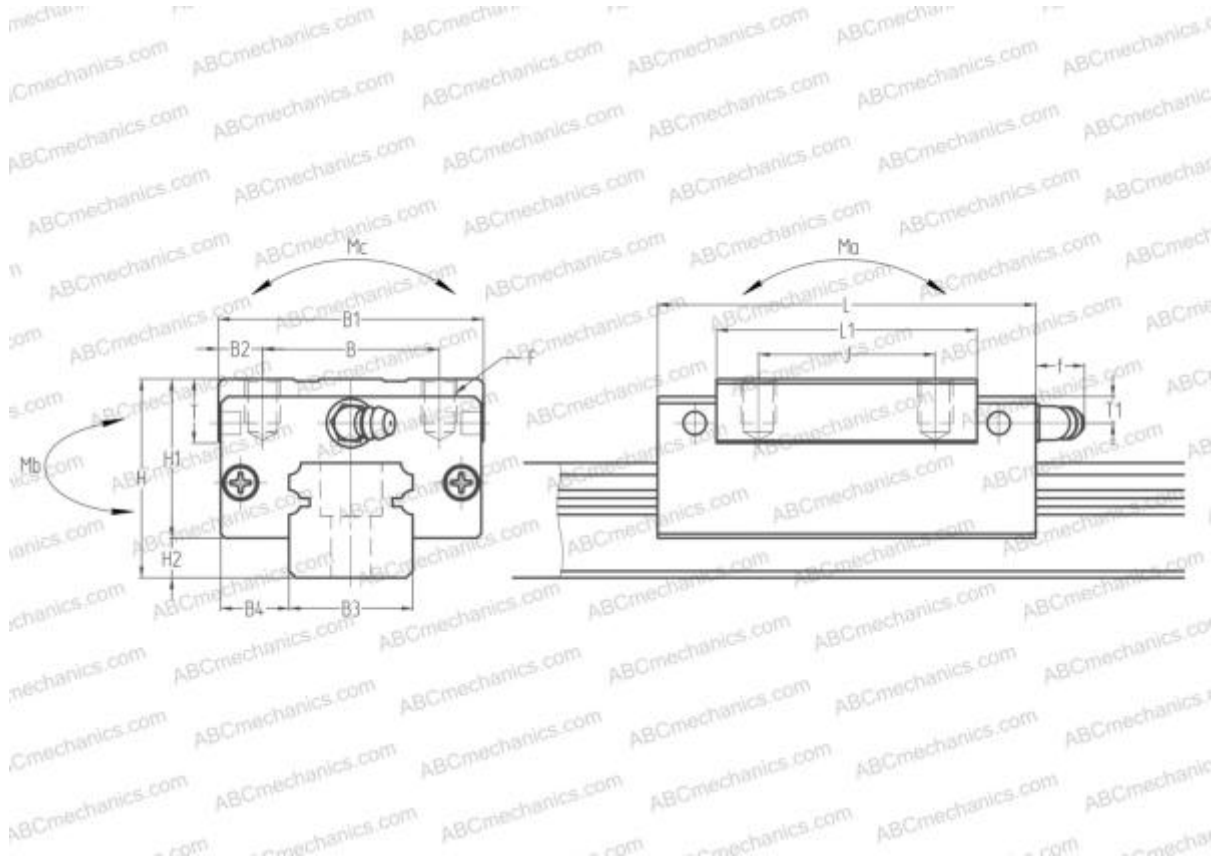

Technical specification

DIMENSIONS, MM

B1	34,000
H	28,000
L	55,000
B	26,000
J	26,000
L1	39,000
D2	7,500
B2	4,000
B3	15,000
B4	9,500
H1	23,400
H2	4,600
T	8,000
T1	8,500
f	3,300

DIMENSIONS, MM

F	M4x0.7x6
---	----------

SLIDE WEIGHT

0,180

MANUFACTURER

[NSK](#)

CALCULATION DATA

Basic dynamic load rating, C	10,100 kN
Basic static load rating, Co	18,800 kN
Static permissible moment, Ma	0,087 kN-m
Static permissible moment, Mb	0,073 kN-m
Static permissible moment, Mc	0,098 kN-m