

SH15BN NSK

Linear guides

TYPE: Monorail guidance systems, Recirculating balls, High vertical load carrying capacity type, Self-aligning type, Square type, High, Ball slide length - long, Mounting tap, Low noise, smooth operation type, Interchangeable part

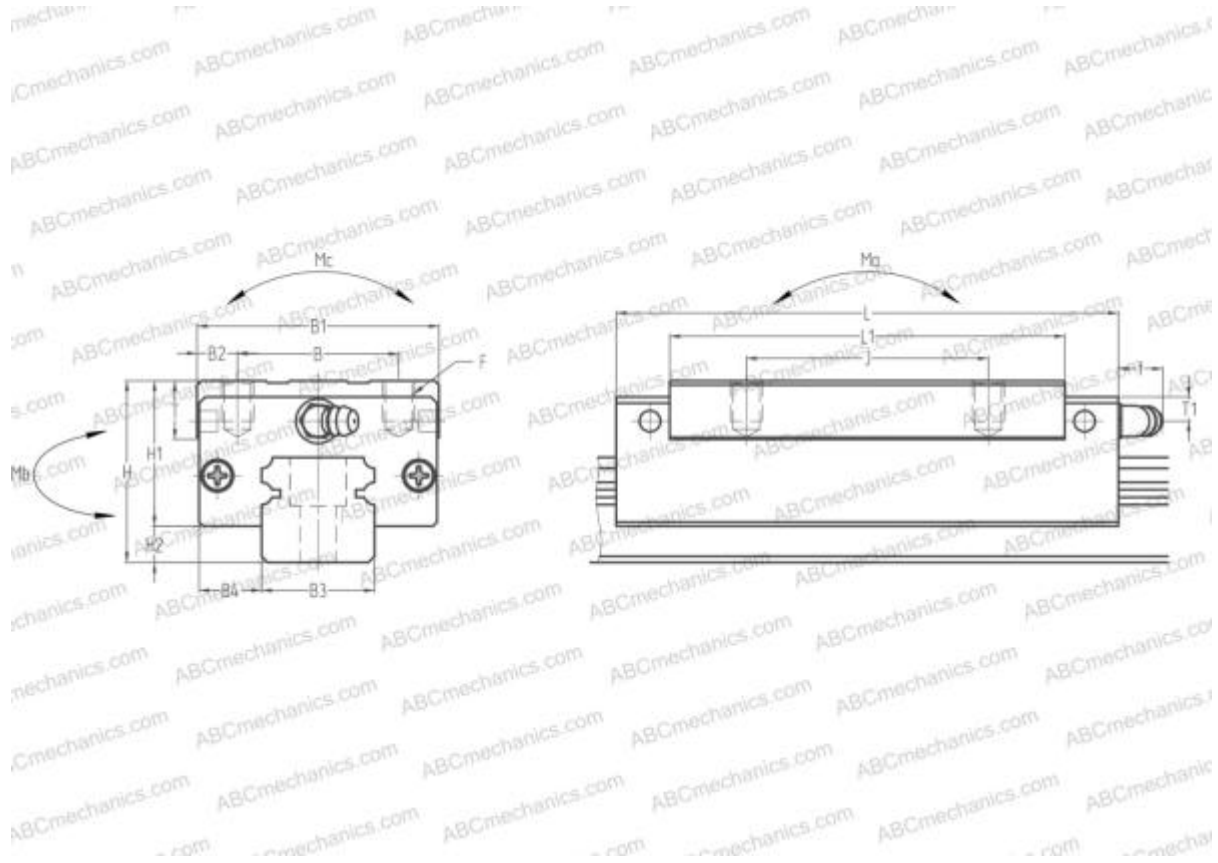

Technical specification

DIMENSIONS, MM

B1	34,000
H	28,000
L	74,000
B	26,000
J	26,000
L1	58,000
D2	7,500
B2	4,000
B3	15,000
B4	9,500
H1	23,400
H2	4,600
T	8,000
T1	8,500
f	3,300

CALCULATION DATA

Basic static load rating, C_0	28,200 kN
Static permissible moment, M_a	0,193 kN-m
Static permissible moment, M_b	0,162 kN-m
Static permissible moment, M_c	0,147 kN-m

INCLUDED PRODUCTS

SAH15BN

DIMENSIONS, MM

C	60,000
d1	4,500
d2	7,500
h	15,000
h1	5,300
L max	2000,000
aL	20,000
aR	20,000
F	M4x0.7x6

WEIGHT

Slide weight	0,260
Rail weight	1,600

MANUFACTURER[NSK](#)**CALCULATION DATA**

Basic dynamic load rating, C	13,400 kN
------------------------------	-----------