

SS30CL ABC

Linear guides

TYPE: Monorail guidance systems, Recirculating balls, High vertical load carrying capacity type, Self-aligning type, Square type, Low, Ball slide length - short, Mounting tap, Low noise, smooth operation type

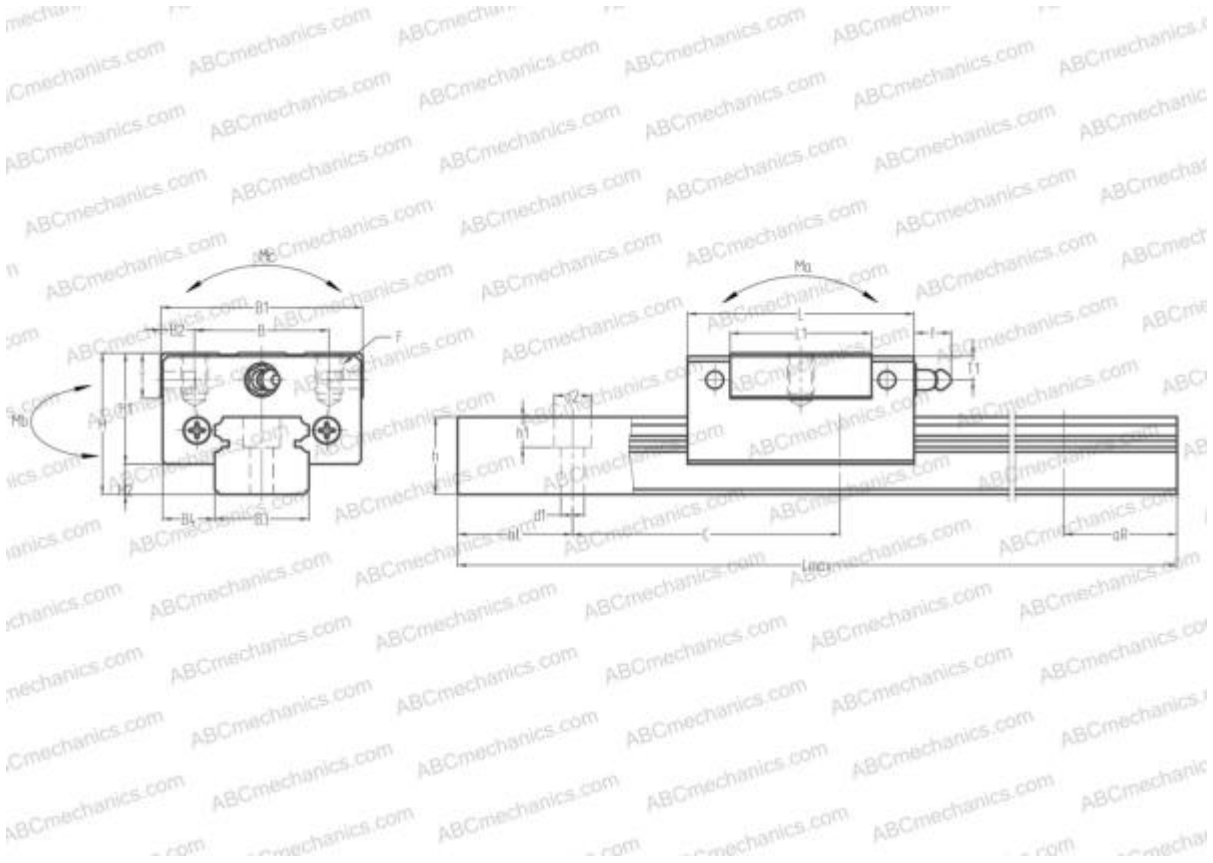

Technical specification

DIMENSIONS, MM

B1	60,000
H	42,000
L	67,400
B	40,000
L1	42,000
D2	14,000
B2	10,000
B3	28,000
B4	16,000
H1	33,000
H2	9,000
T	13,000
T1	8,000
f	11,000
C	80,000

DIMENSIONS, MM

d1	7,000
d2	11,000
h	23,000
h1	9,000
L max	4000,000
aL	20,000
aR	20,000
F	M8x1.25x12

WEIGHT

Slide weight	0,580
Rail weight	4,800

MANUFACTURER

[ABC](#)

INTERCHANGE

NSK	SS30CL
-----	------------------------

