

HSR65A THK

Linear guides

TYPE: Monorail guidance systems, Recirculating balls, High vertical load carrying capacity type, Self-aligning type, Flanged type, Low, Ball slide length - standard, Mounting tap

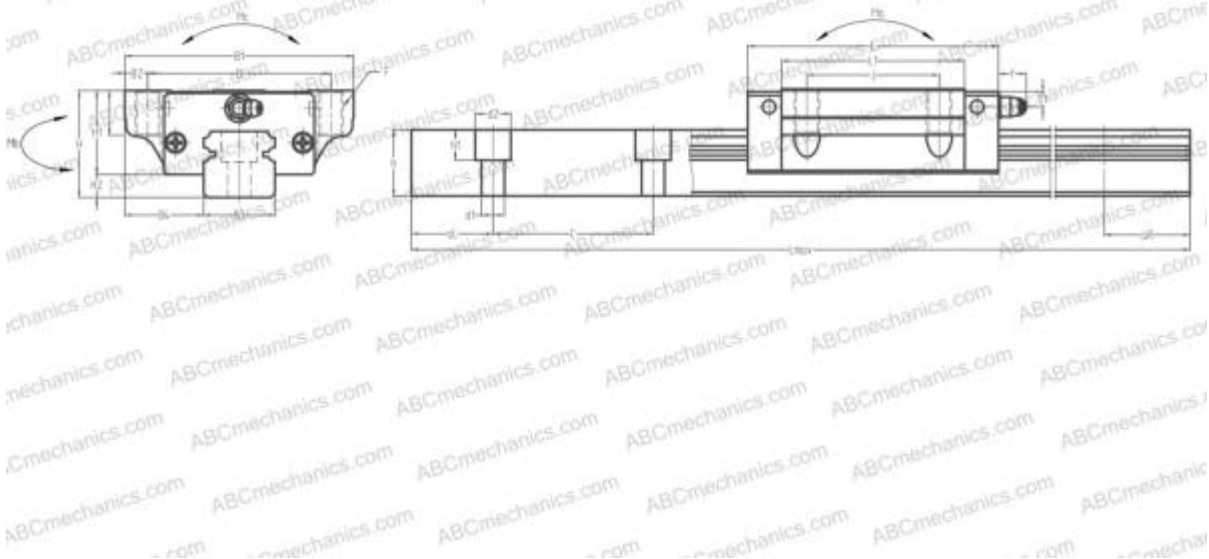

Technical specification

DIMENSIONS, MM

B1	170,000
H	90,000
L	193,000
B	142,000
J	110,000
L1	147,000
B2	14,000
B3	63,000
B4	53,500
H1	74,000
H2	16,000
T	23,000
T1	19,000
f	13,000
C	150,000

DIMENSIONS, MM

d1	18,000
d2	26,000
h	53,000
h1	22,000
L max	3900,000
aL	35,000
aR	35,000
F	M16x2x24

WEIGHT

Slide weight	10,000
Rail weight	24,300

MANUFACTURER

[THK](#)

INTERCHANGE

ABC	LH65EL
NSK	LH65EL

INTERCHANGE

IKO	LWHT65..B
HIWIN	HGW65CA
STAR	1651-6