

## LAH25GL NSK

Linear guides

TYPE: Monorail guidance systems, Recirculating balls, High vertical load carrying capacity type, Self-aligning type, Flanged type, Low, Ball slide length - long, Mounting tap, Interchangeable part

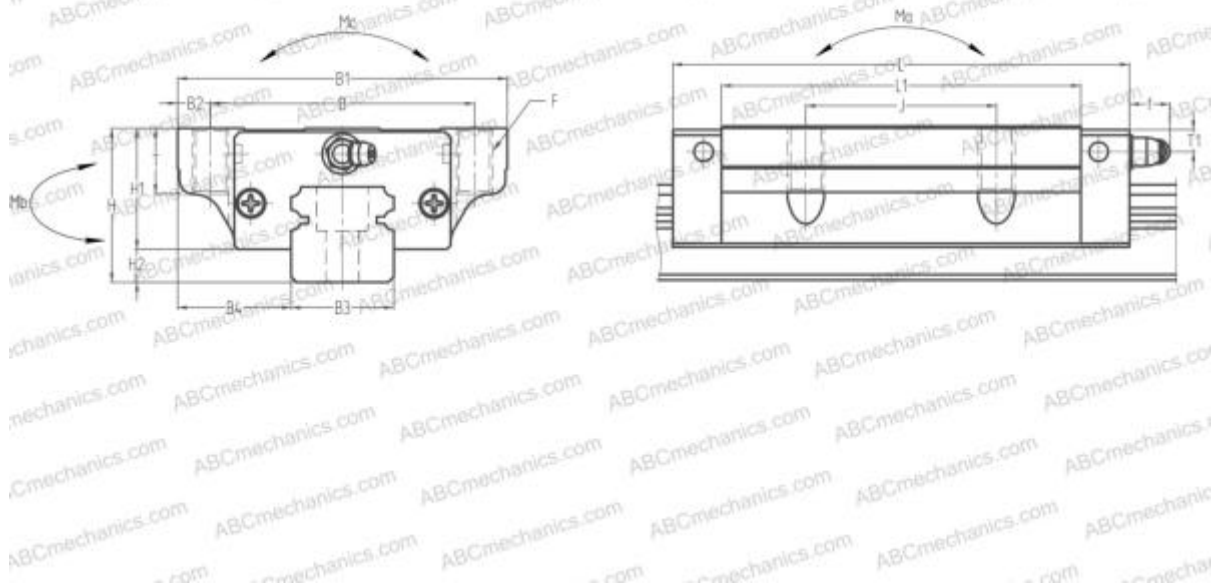

### Technical specification

#### DIMENSIONS, MM

B1	70,000
H	36,000
L	107,000
B	57,000
J	45,000
L1	86,000
B2	6,500
B3	23,000
B4	23,500
H1	29,000
H2	7,000
T	11,000
T1	6,000
f	11,000
F	M8x1.25x16

#### SLIDE WEIGHT

0,930

#### MANUFACTURER

[NSK](#)

#### CALCULATION DATA

Basic dynamic load rating, C	26,900 kN
Basic static load rating, Co	52,500 kN
Static permissible moment, Ma	0,530 kN-m
Static permissible moment, Mb	0,520 kN-m
Static permissible moment, Mc	0,470 kN-m