

## LAH30GL NSK

Linear guides

TYPE: Monorail guidance systems, Recirculating balls, High vertical load carrying capacity type, Self-aligning type, Flanged type, Low, Ball slide length - long, Mounting tap, Interchangeable part

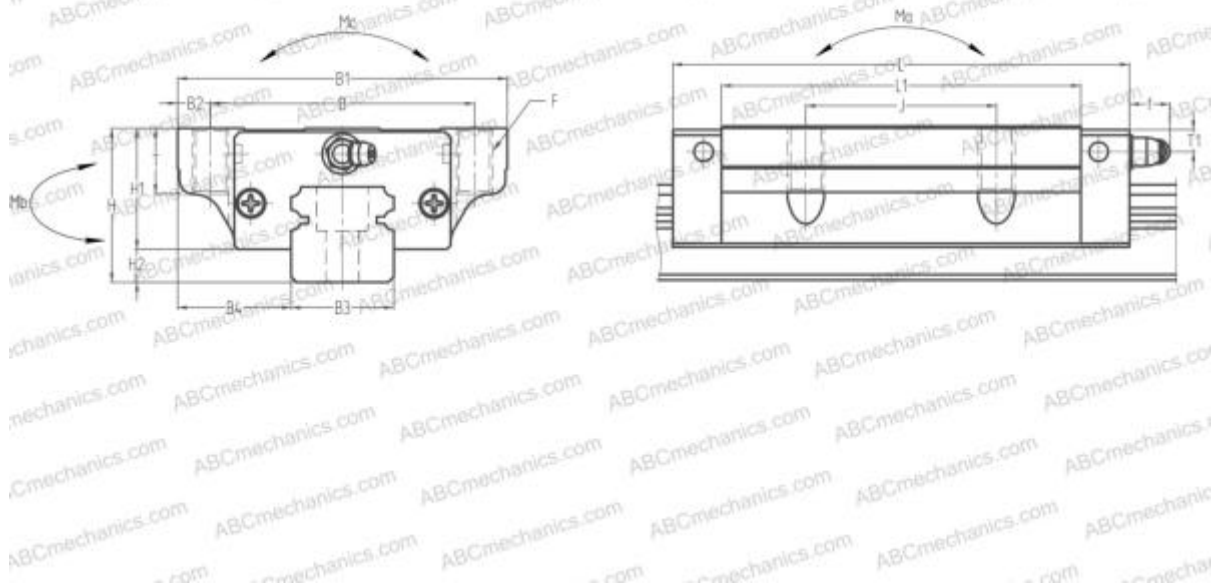

### Technical specification

#### DIMENSIONS, MM

B1	90,000
H	42,000
L	124,600
B	72,000
J	52,000
L1	98,000
B2	9,000
B3	28,000
B4	31,000
H1	33,000
H2	9,000
T	11,000
T1	7,000
f	11,000
F	M10x1.5x18

#### SLIDE WEIGHT

1,600

#### MANUFACTURER

[NSK](#)

#### CALCULATION DATA

Basic dynamic load rating, C	37,500 kN
Basic static load rating, Co	71,500 kN
Static permissible moment, Ma	0,845 kN-m
Static permissible moment, Mb	0,835 kN-m
Static permissible moment, Mc	0,785 kN-m