

## LAH35GL NSK

Linear guides

TYPE: Monorail guidance systems, Recirculating balls, High vertical load carrying capacity type, Self-aligning type, Flanged type, Low, Ball slide length - long, Mounting tap, Interchangeable part

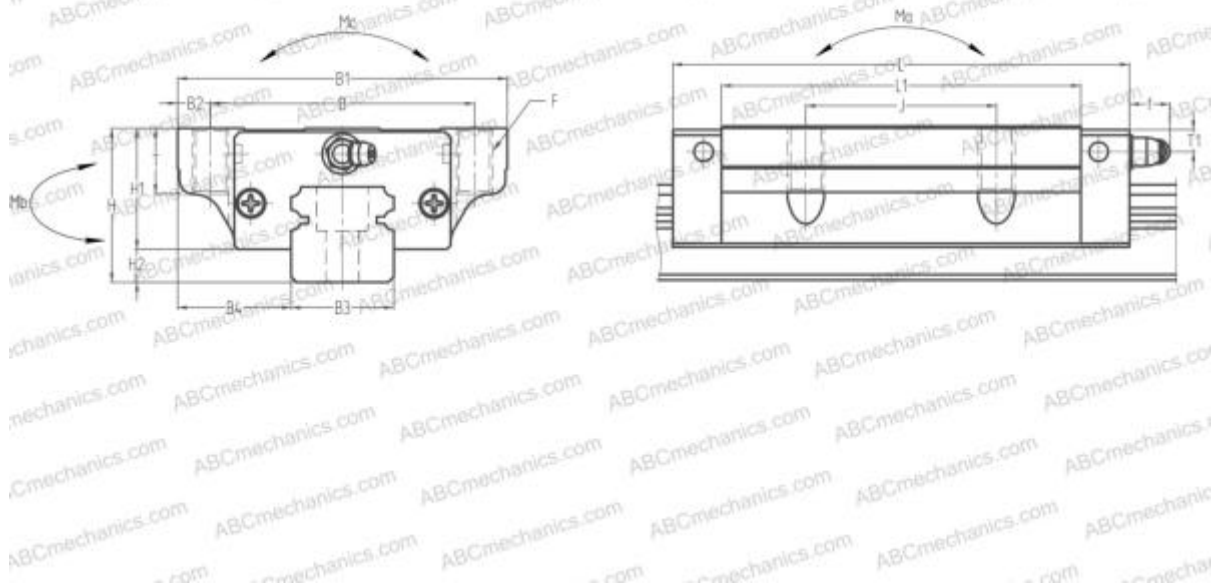

### Technical specification

#### DIMENSIONS, MM

B1	100,000
H	48,000
L	143,000
B	82,000
J	62,000
L1	114,000
B2	9,000
B3	34,000
B4	33,000
H1	38,500
H2	9,500
T	12,000
T1	8,000
f	11,000
F	M10x1.5x20

#### SLIDE WEIGHT

2,400

#### MANUFACTURER

[NSK](#)

#### CALCULATION DATA

Basic dynamic load rating, C	49,500 kN
Basic static load rating, Co	97,500 kN
Static permissible moment, Ma	1,410 kN-m
Static permissible moment, Mb	1,380 kN-m
Static permissible moment, Mc	1,330 kN-m