

LAH20FL NSK

Linear guides

TYPE: Monorail guidance systems, Recirculating balls, High vertical load carrying capacity type, Self-aligning type, Flanged type, Low, Ball slide length - standard, Mounting bolt hole, Interchangeable part

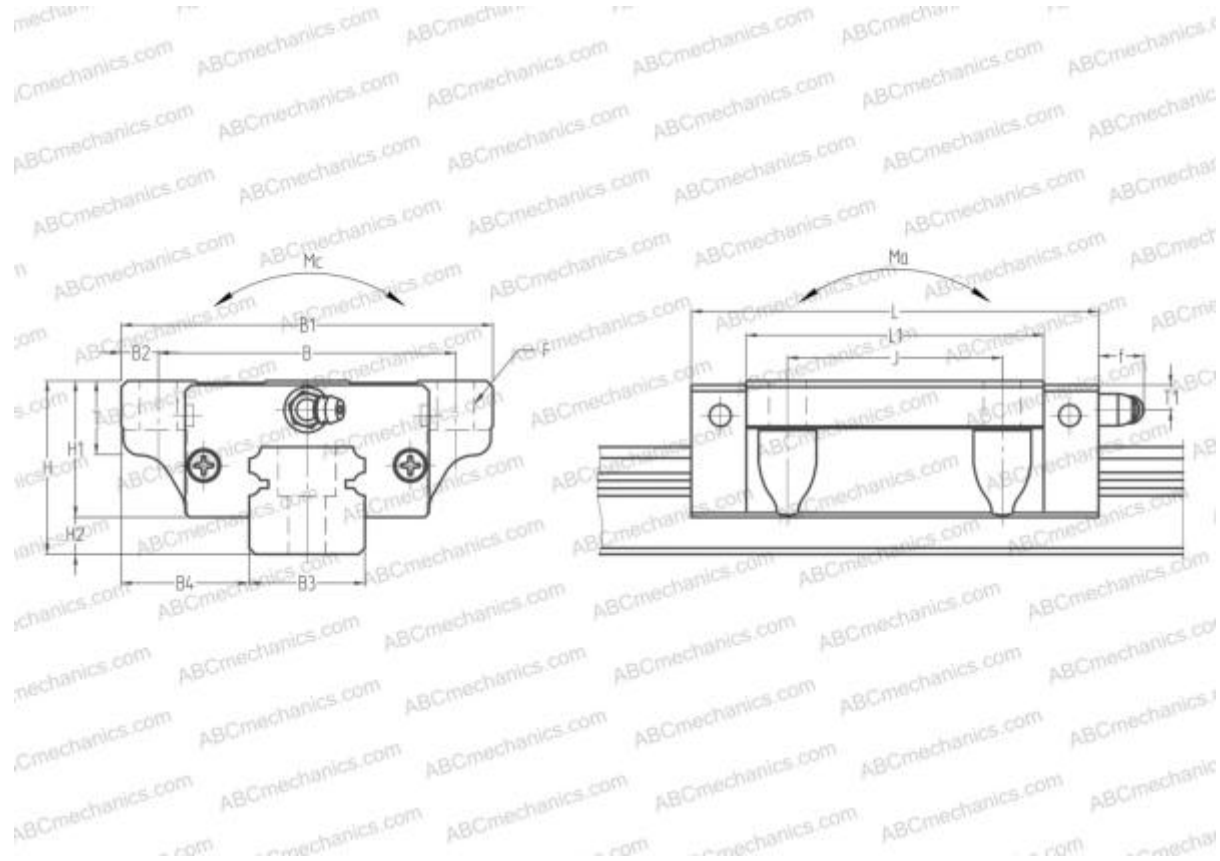

Technical specification

DIMENSIONS, MM

B1	63,000
H	30,000
L	69,800
B	53,000
J	40,000
L1	50,000
B2	5,000
B3	20,000
B4	21,500
H1	25,000
H2	5,000
T	10,000
T1	5,000
f	11,000
F	6x10

SLIDE WEIGHT

0,450

MANUFACTURER

[NSK](#)

CALCULATION DATA

Basic dynamic load rating, C	14,200 kN
Basic static load rating, Co	25,100 kN
Static permissible moment, Ma	0,177 kN-m
Static permissible moment, Mb	0,177 kN-m
Static permissible moment, Mc	0,216 kN-m