

## LAH25FL NSK

Linear guides

TYPE: Monorail guidance systems, Recirculating balls, High vertical load carrying capacity type, Self-aligning type, Flanged type, Low, Ball slide length - standard, Mounting bolt hole, Interchangeable part

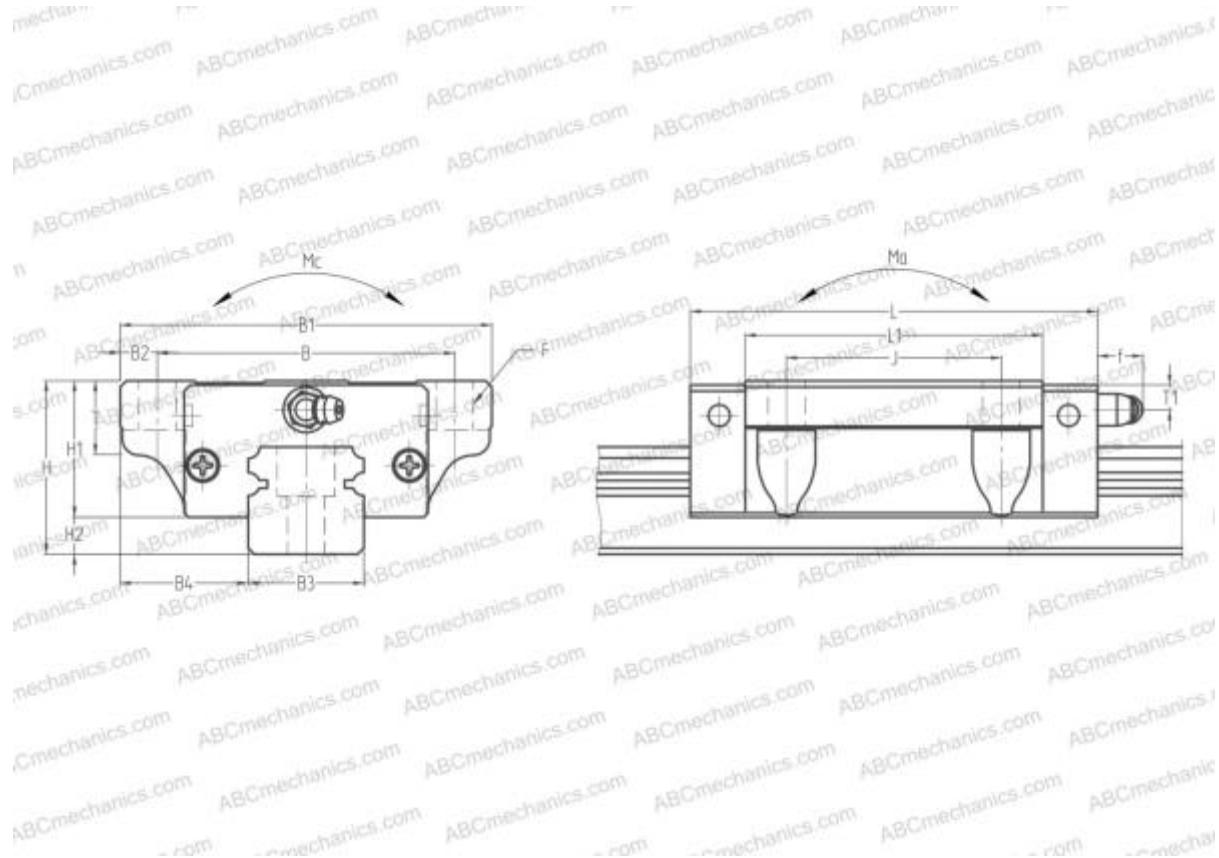

### Technical specification

#### DIMENSIONS, MM

B1	70,000
H	36,000
L	79,000
B	57,000
J	45,000
L1	58,000
B2	6,500
B3	23,000
B4	23,500
H1	29,000
H2	7,000
T	11,000
T1	6,000
f	11,000
F	7x10

#### SLIDE WEIGHT

0,630

#### MANUFACTURER

[NSK](#)

#### CALCULATION DATA

Basic dynamic load rating, C	21,000 kN
Basic static load rating, Co	39,000 kN
Static permissible moment, Ma	0,315 kN-m
Static permissible moment, Mb	0,305 kN-m
Static permissible moment, Mc	0,355 kN-m