

LAH30FL NSK

Linear guides

TYPE: Monorail guidance systems, Recirculating balls, High vertical load carrying capacity type, Self-aligning type, Flanged type, Low, Ball slide length - standard, Mounting bolt hole, Interchangeable part

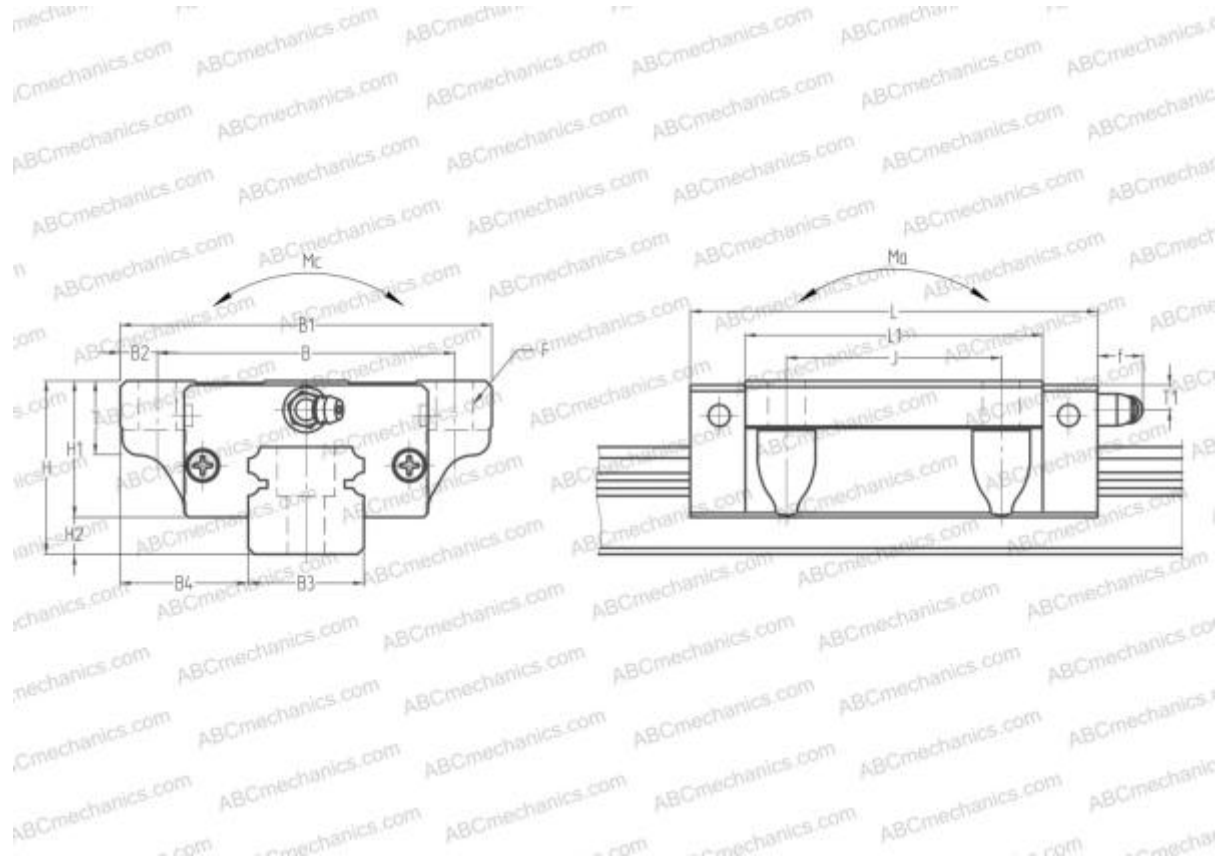

Technical specification

DIMENSIONS, MM

B1	90,000
H	42,000
L	98,600
B	72,000
J	52,000
L1	72,000
B2	9,000
B3	28,000
B4	31,000
H1	33,000
H2	9,000
T	11,000
T1	7,000
f	11,000
F	9x12

SLIDE WEIGHT

1,200

MANUFACTURER

[NSK](#)

CALCULATION DATA

Basic dynamic load rating, C	29,200 kN
Basic static load rating, Co	54,000 kN
Static permissible moment, Ma	0,490 kN-m
Static permissible moment, Mb	0,480 kN-m
Static permissible moment, Mc	0,590 kN-m