

LAH35FL NSK

Linear guides

TYPE: Monorail guidance systems, Recirculating balls, High vertical load carrying capacity type, Self-aligning type, Flanged type, Low, Ball slide length - standard, Mounting bolt hole, Interchangeable part

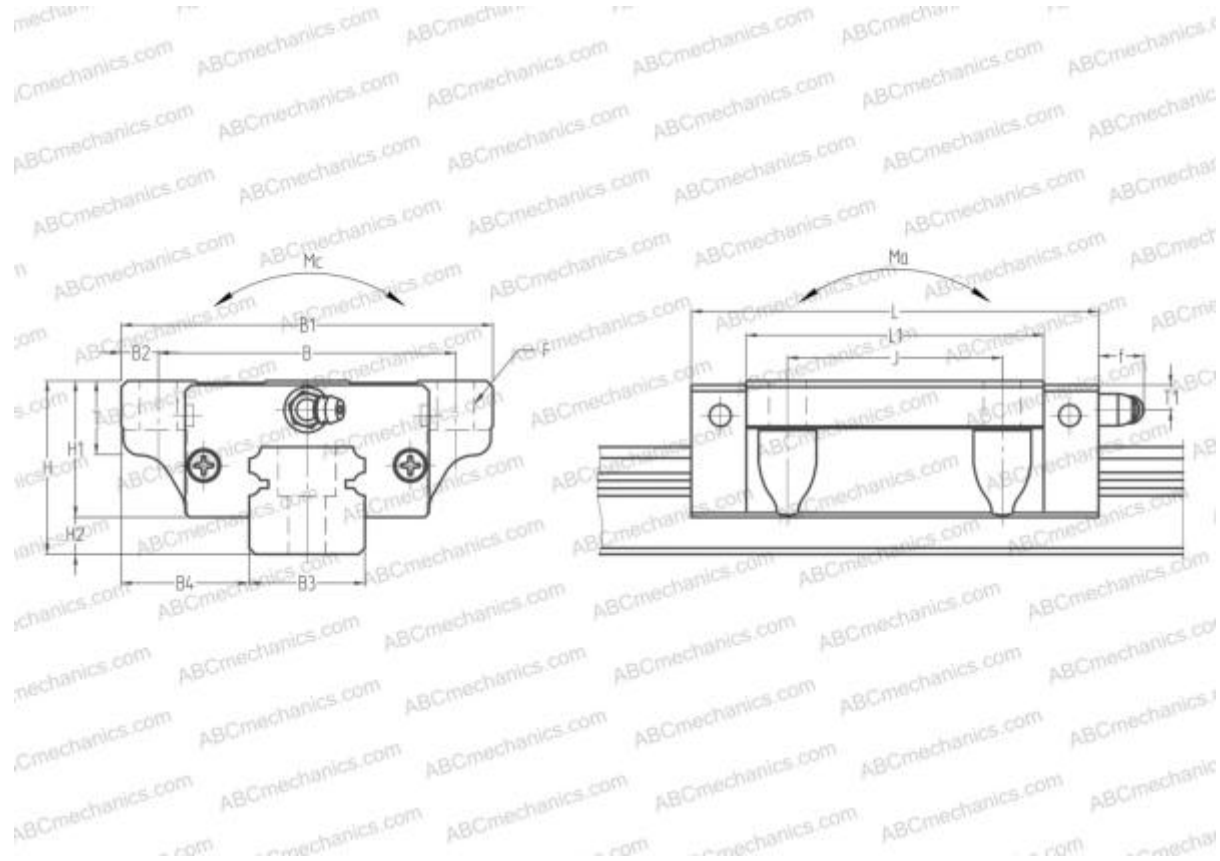

Technical specification

DIMENSIONS, MM

B1	100,000
H	48,000
L	109,000
B	82,000
J	62,000
L1	80,000
B2	9,000
B3	34,000
B4	33,000
H1	38,500
H2	9,500
T	12,000
T1	8,000
f	11,000
F	9x13

SLIDE WEIGHT

1,700

MANUFACTURER

[NSK](#)

CALCULATION DATA

Basic dynamic load rating, C	39,000 kN
Basic static load rating, Co	68,500 kN
Static permissible moment, Ma	0,745 kN-m
Static permissible moment, Mb	0,715 kN-m
Static permissible moment, Mc	0,940 kN-m