

LAH55FL NSK

Linear guides

TYPE: Monorail guidance systems, Recirculating balls, High vertical load carrying capacity type, Self-aligning type, Flanged type, Low, Ball slide length - standard, Mounting bolt hole, Interchangeable part

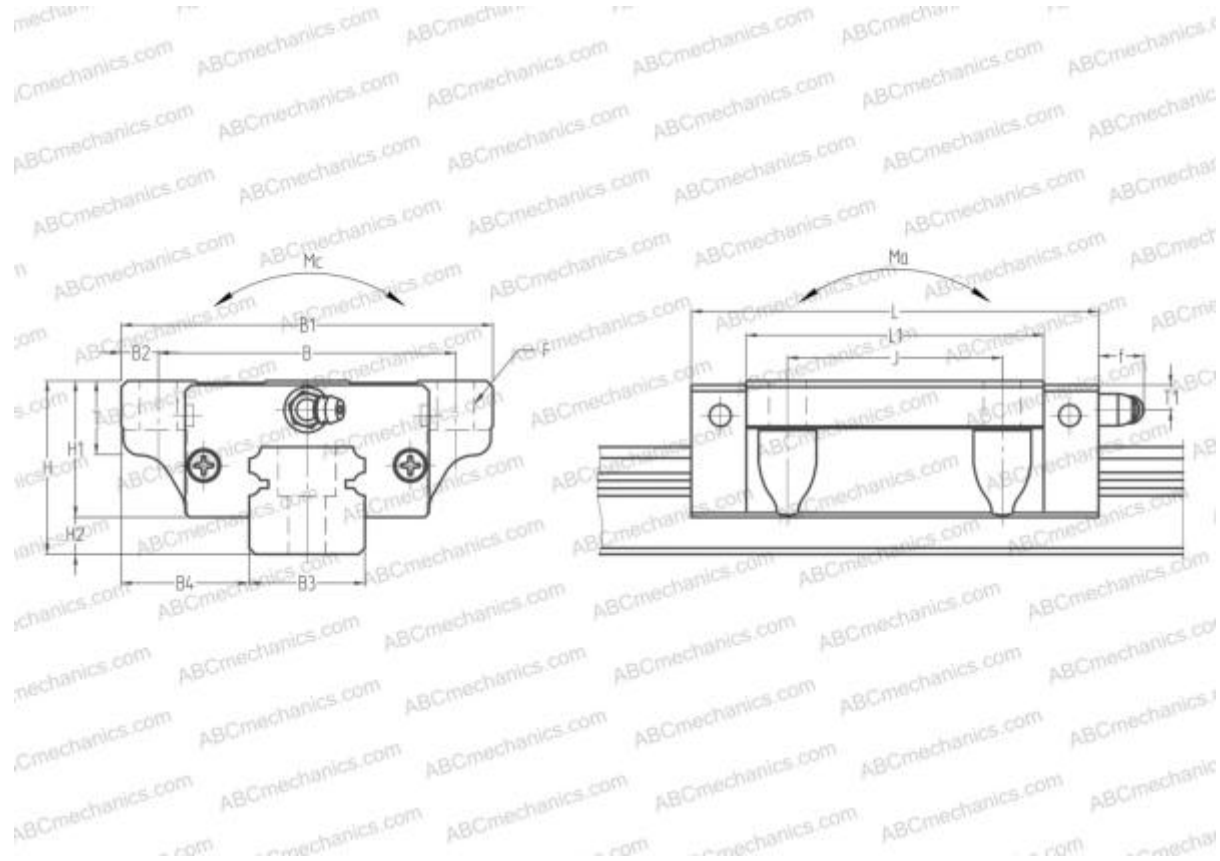

Technical specification

DIMENSIONS, MM

B1	140,000
H	70,000
L	163,000
B	116,000
J	95,000
L1	126,000
B2	12,000
B3	53,000
B4	43,500
H1	55,000
H2	15,000
T	15,000
T1	11,000
f	13,000
F	14x18

SLIDE WEIGHT

5,000

MANUFACTURER

[NSK](#)

CALCULATION DATA

Basic dynamic load rating, C	97,500 kN
Basic static load rating, Co	168,000 kN
Static permissible moment, Ma	2,870 kN-m
Static permissible moment, Mb	2,820 kN-m
Static permissible moment, Mc	3,600 kN-m