

LAH55HL NSK

Linear guides

TYPE: Monorail guidance systems, Recirculating balls, High vertical load carrying capacity type, Self-aligning type, Flanged type, Low, Ball slide length - long, Mounting bolt hole, Interchangeable part

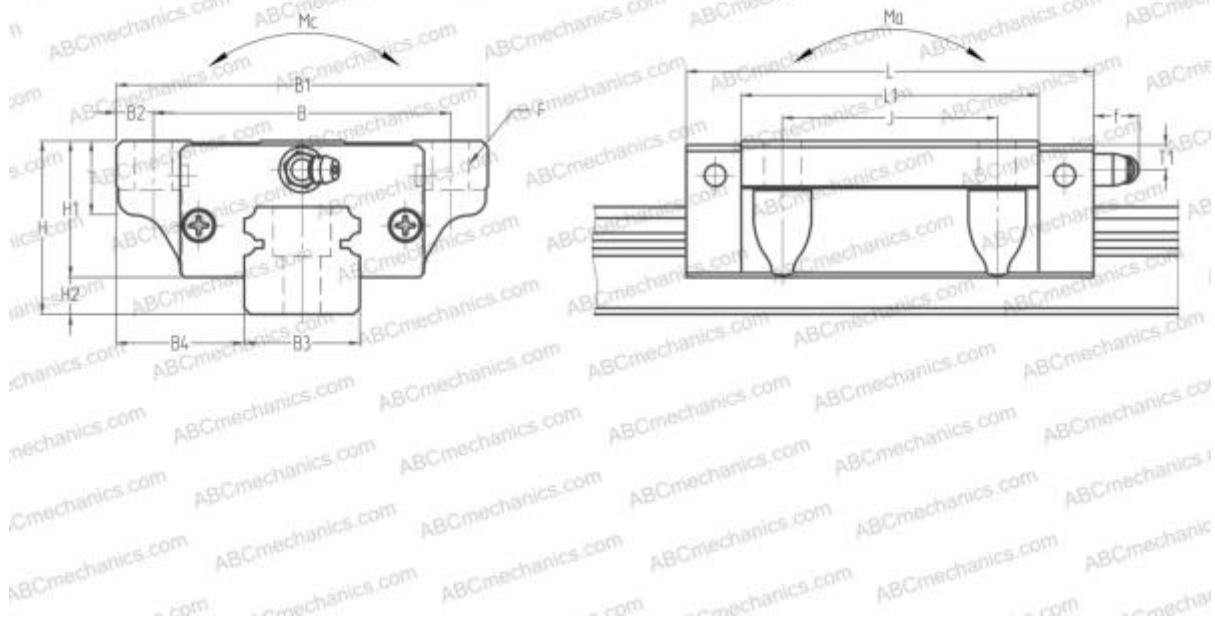

Technical specification

DIMENSIONS, MM

B1	140,000
H	70,000
L	201,000
B	116,000
J	95,000
L1	164,000
B2	12,000
B3	53,000
B4	43,500
H1	55,000
H2	15,000
T	15,000
T1	11,000
f	13,000
F	14x18

SLIDE WEIGHT

6,500

MANUFACTURER

[NSK](#)

CALCULATION DATA

Basic dynamic load rating, C	118,000 kN
Basic static load rating, Co	207,000 kN
Static permissible moment, Ma	4,250 kN-m
Static permissible moment, Mb	4,150 kN-m
Static permissible moment, Mc	4,400 kN-m