

LWET15 IKO

Linear guides

TYPE: Monorail guidance systems, Recirculating balls, High vertical load carrying capacity type, Self-aligning type, Flanged type, Low, Ball slide length - standard, Mounting tap, Compact

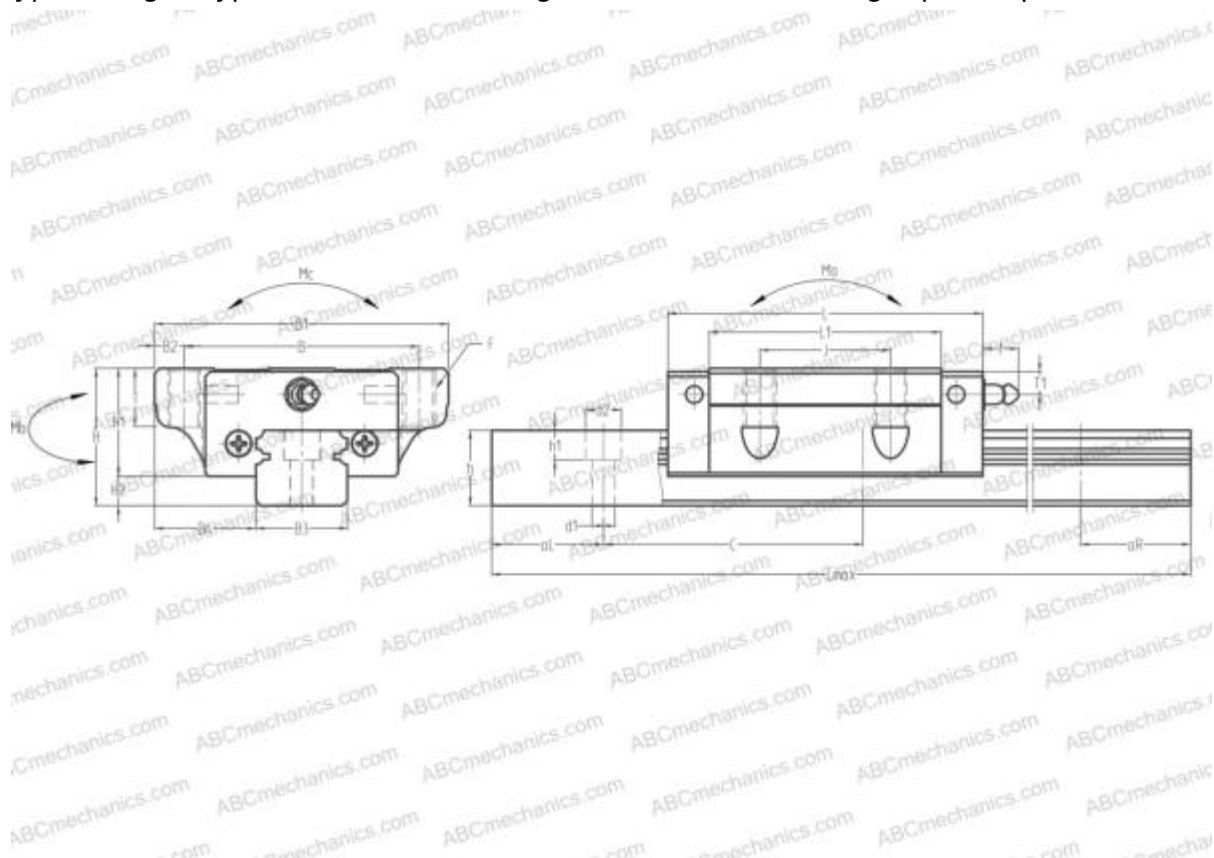

Technical specification

DIMENSIONS, MM

B1	52,000
H	24,000
L	56,800
B	41,000
J	26,000
L1	40,000
B2	5,500
B3	15,000
B4	18,500
H1	19,400
H2	4,600
T	8,000
T1	6,000
f	3,000
C	60,000

DIMENSIONS, MM

d1	3,500
d2	6,000
h	12,500
h1	4,500
L max	2000,000
aL	20,000
aR	20,000
F	M5x0.8x8

WEIGHT

Slide weight	0,260
Rail weight	1,400

MANUFACTURER

[IKO](#)

INTERCHANGE

ABC	LS15EL
NSK	LS15EL

INTERCHANGE

HIWIN	EGW15CA
NB	SGL15TE
THOMSON	AT 15G