

LAS30EL NSK

Linear guides

TYPE: Monorail guidance systems, Recirculating balls, High vertical load carrying capacity type, Self-aligning type, Flanged type, Low, Ball slide length - standard, Mounting tap, Compact, Interchangeable part

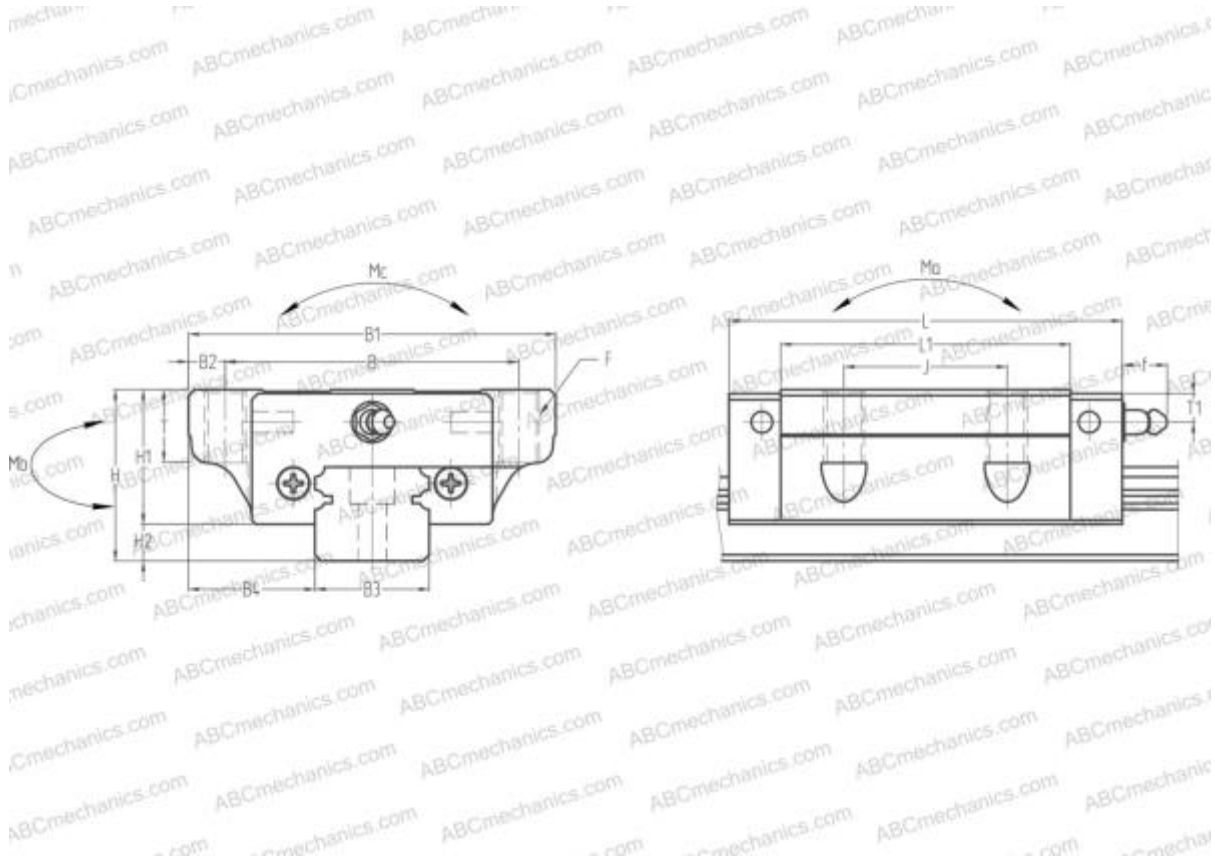

Technical specification

DIMENSIONS, MM

B1	90,000
H	42,000
L	96,400
B	72,000
J	40,000
L1	71,000
B2	9,000
B3	28,000
B4	31,000
H1	33,000
H2	9,000
T	11,000
T1	8,000
f	11,000
F	M10x1.5x18

SLIDE WEIGHT

1,200

MANUFACTURER

[NSK](#)

CALCULATION DATA

Basic dynamic load rating, C	23,400 kN
Basic static load rating, Co	43,000 kN
Static permissible moment, Ma	355,000 kN-m
Static permissible moment, Mb	355,000 kN-m
Static permissible moment, Mc	470,000 kN-m