

AGW15SA HIWIN

Linear guides

TYPE: Monorail guidance systems, Recirculating balls, High vertical load carrying capacity type, Self-aligning type, Flanged type, Low, Ball slide length - short, Mounting tap, Compact

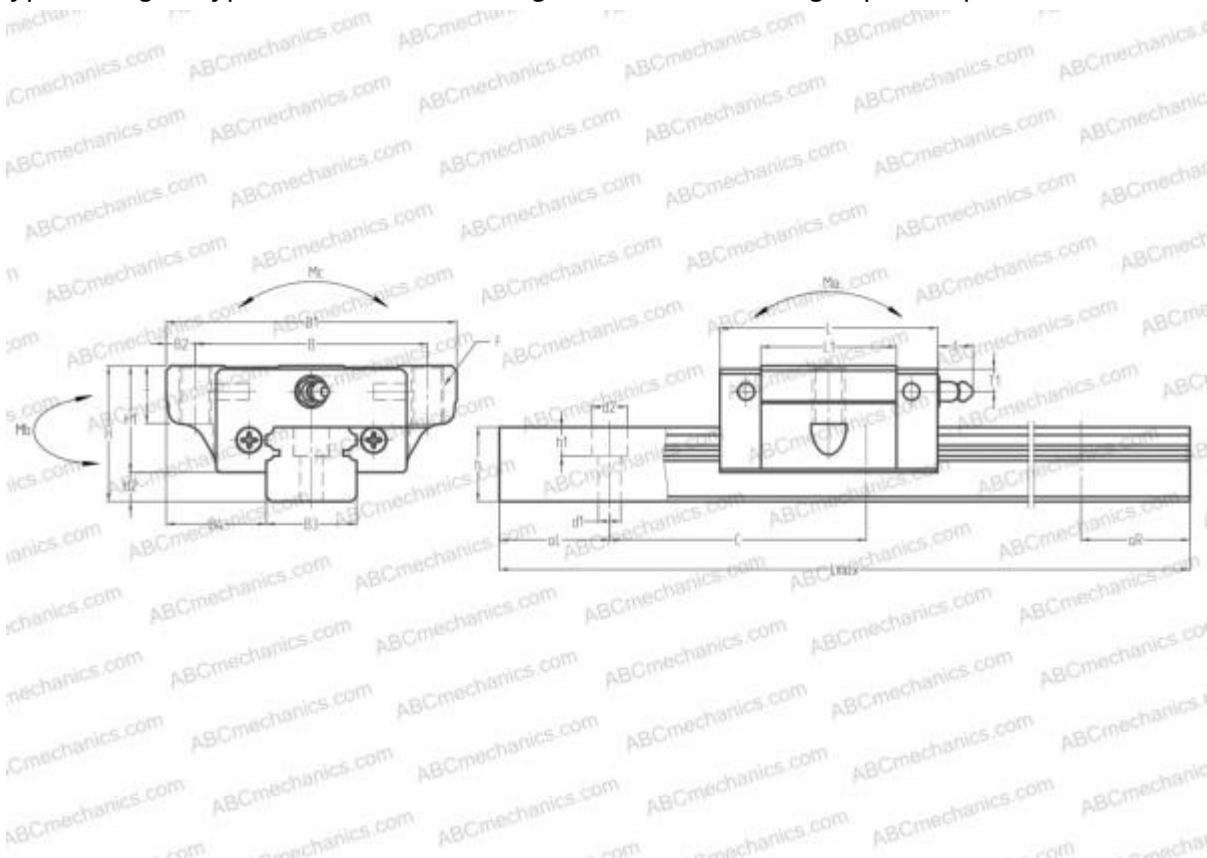

Technical specification

DIMENSIONS, MM

B1	52,000
H	24,000
L	40,400
B	41,000
L1	23,600
B2	5,500
B3	15,000
B4	18,500
H1	19,400
H2	4,600
T	8,000
T1	6,000
f	3,000
C	60,000
d1	3,500

DIMENSIONS, MM

d2	6,000
h	12,500
h1	4,500
L max	2000,000
aL	20,000
aR	20,000
F	M5x0.8x8

WEIGHT

Slide weight	0,170
Rail weight	1,400

MANUFACTURER

[HIWIN](#)

INTERCHANGE

ABC	LS15JL
NSK	LS15JL
IKO	LWETC15