

LWETC35 IKO

Linear guides

TYPE: Monorail guidance systems, Recirculating balls, High vertical load carrying capacity type, Self-aligning type, Flanged type, Low, Ball slide length - short, Mounting tap, Compact

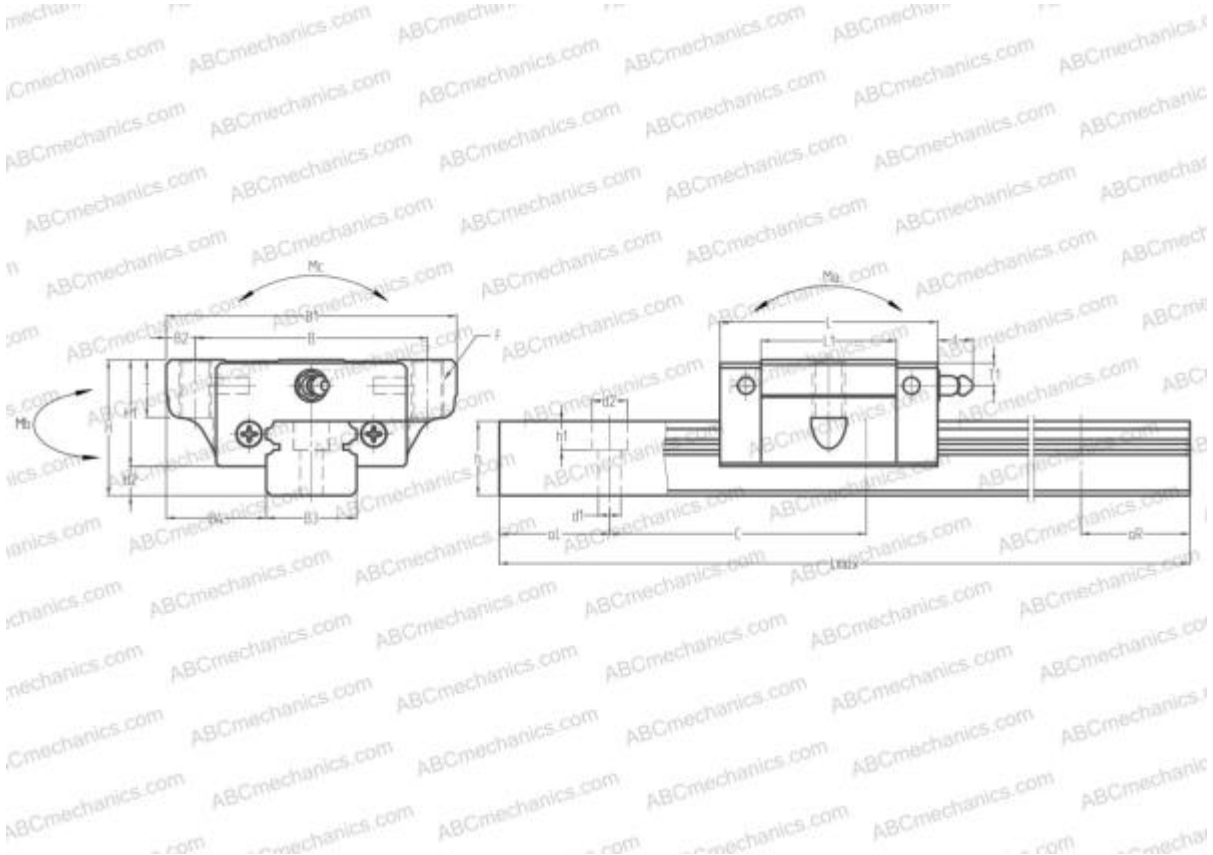

Technical specification

DIMENSIONS, MM

B1	100,000
H	48,000
L	77,000
B	82,000
L1	49,000
B2	9,000
B3	34,000
B4	33,000
H1	37,500
H2	10,500
T	12,000
T1	8,500
f	11,000
C	80,000
d1	9,000

DIMENSIONS, MM

d2	14,000
h	27,500
h1	12,000
L max	4000,000
aL	20,000
aR	20,000
F	M10x1.5x20

WEIGHT

Slide weight	1,200
Rail weight	7,000

MANUFACTURER

[IKO](#)

INTERCHANGE

ABC	LS35JL
NSK	LS35JL
HIWIN	AGW35SA

INTERCHANGE

STAR

[1665-3](#)