

LAS15JL NSK

Linear guides

TYPE: Monorail guidance systems, Recirculating balls, High vertical load carrying capacity type, Self-aligning type, Flanged type, Low, Ball slide length - short, Mounting tap, Compact, Interchangeable part

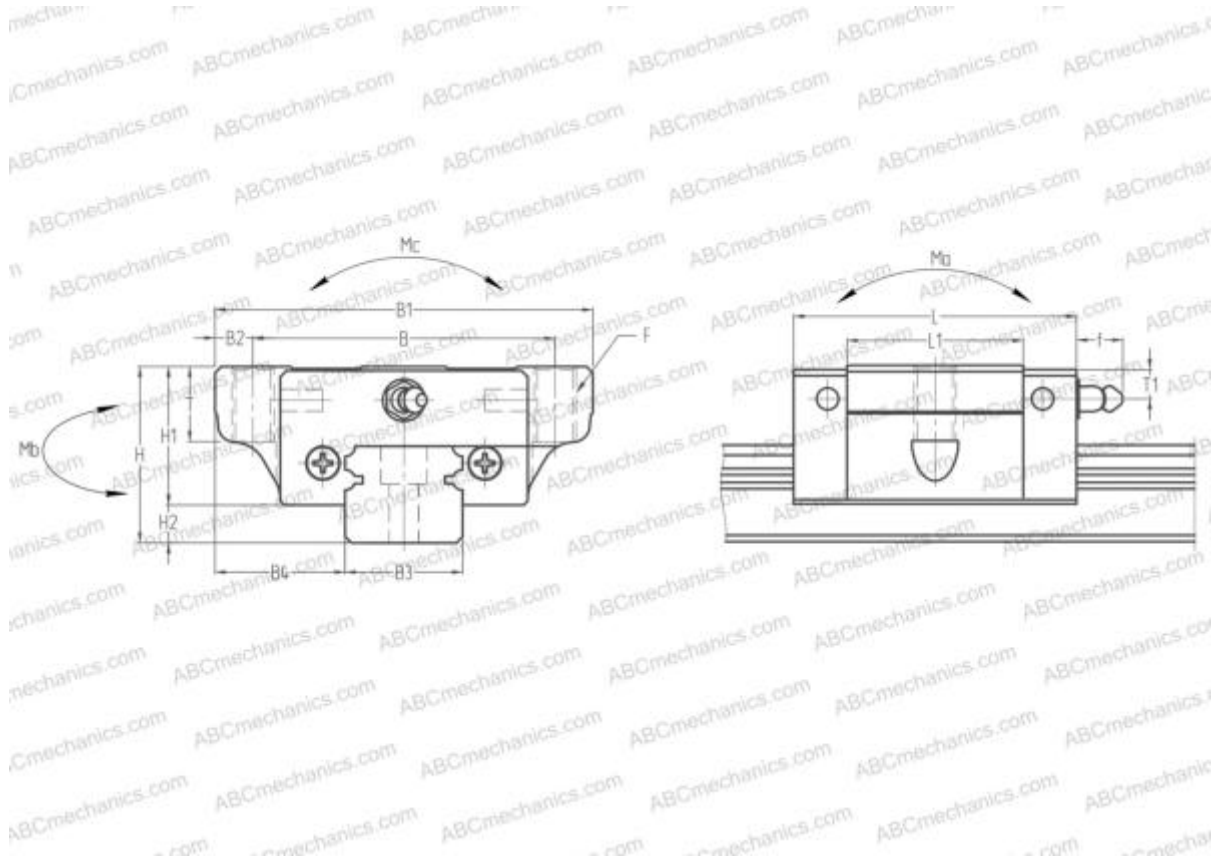

Technical specification

DIMENSIONS, MM

B1	52,000
H	24,000
L	40,400
B	41,000
L1	23,600
B2	5,500
B3	15,000
B4	18,500
H1	19,400
H2	4,600
T	8,000
T1	6,000
f	3,000
F	M5x0.8x8

SLIDE WEIGHT

0,170

MANUFACTURER

[NSK](#)

CALCULATION DATA

Basic dynamic load rating, C	4,550 kN
Basic static load rating, Co	8,300 kN
Static permissible moment, Ma	20,000 kN-m
Static permissible moment, Mb	20,000 kN-m
Static permissible moment, Mc	39,000 kN-m