

LAS25JL NSK

Linear guides

TYPE: Monorail guidance systems, Recirculating balls, High vertical load carrying capacity type, Self-aligning type, Flanged type, Low, Ball slide length - short, Mounting tap, Compact, Interchangeable part

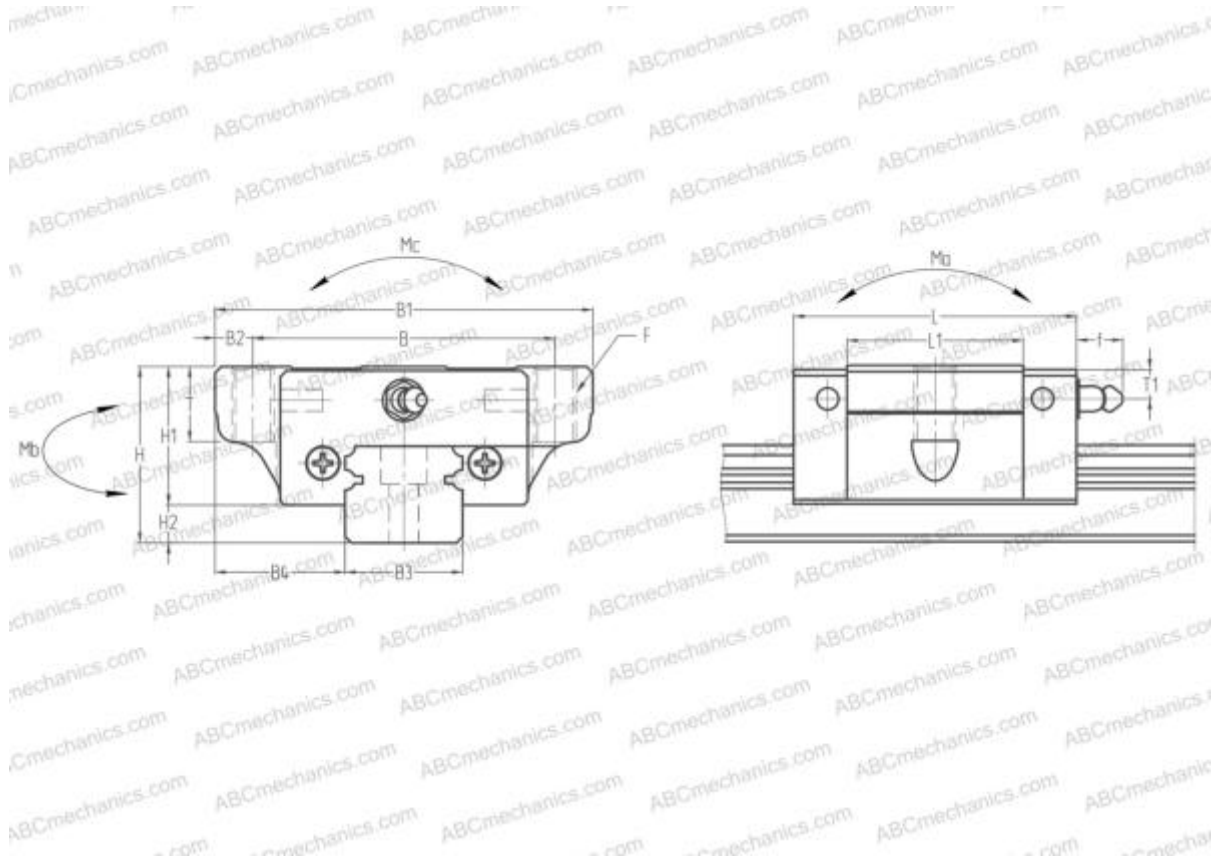

Technical specification

DIMENSIONS, MM

B1	73,000
H	33,000
L	59,600
B	60,000
L1	38,000
B2	6,500
B3	23,000
B4	25,000
H1	26,000
H2	7,000
T	11,000
T1	7,000
f	11,000
F	M8x1.25x12

SLIDE WEIGHT

0,440

MANUFACTURER

[NSK](#)

CALCULATION DATA

Basic dynamic load rating, C	10,600 kN
Basic static load rating, Co	18,600 kN
Static permissible moment, Ma	69,000 kN-m
Static permissible moment, Mb	69,000 kN-m
Static permissible moment, Mc	137,000 kN-m