

LAS15FL NSK

Linear guides

TYPE: Monorail guidance systems, Recirculating balls, High vertical load carrying capacity type, Self-aligning type, Flanged type, Low, Ball slide length - standard, Mounting bolt hole, Compact, Interchangeable part

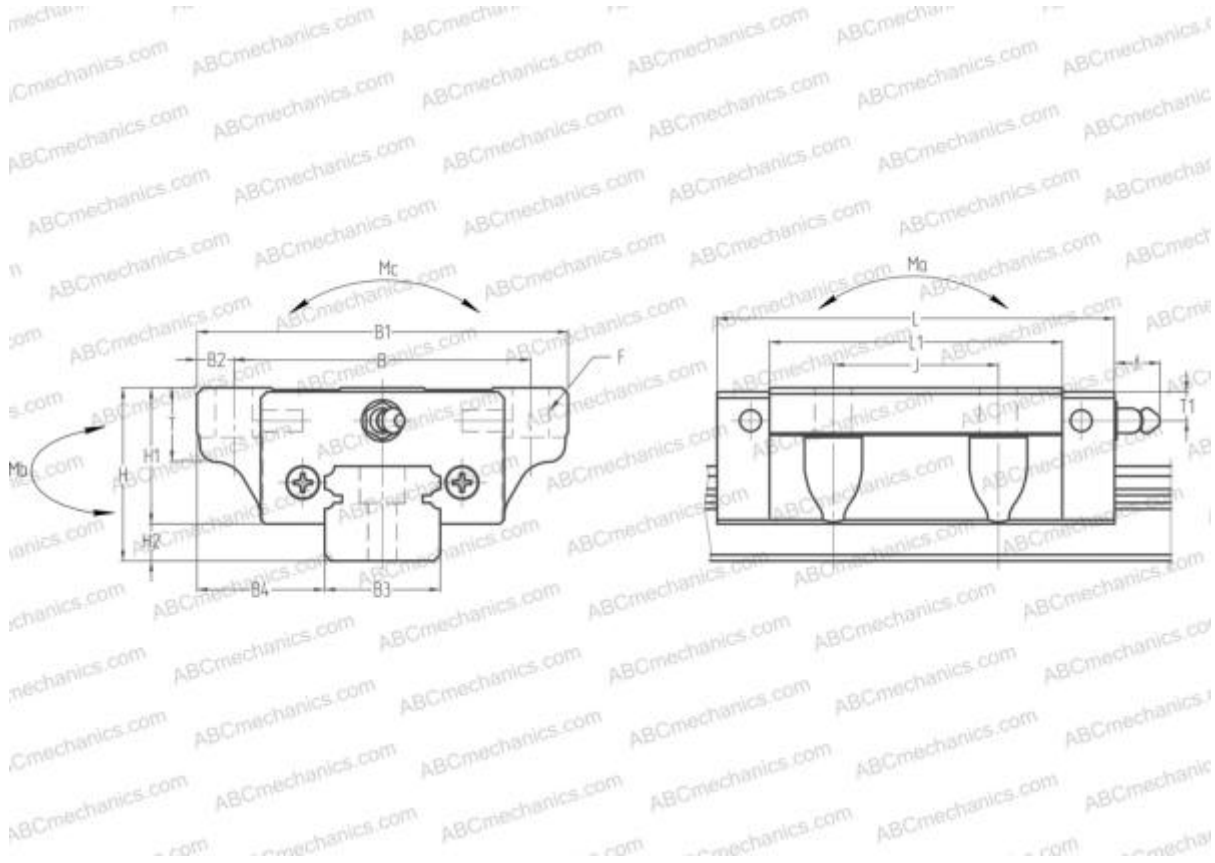

Technical specification

DIMENSIONS, MM

B1	52,000
H	24,000
L	56,800
B	41,000
J	26,000
L1	40,000
B2	5,500
B3	15,000
B4	18,500
H1	19,400
H2	4,600
T	8,000
T1	6,000
f	3,000
F	4.5x7

SLIDE WEIGHT

0,260

MANUFACTURER

[NSK](#)

CALCULATION DATA

Basic dynamic load rating, C	6,700 kN
Basic static load rating, Co	12,500 kN
Static permissible moment, Ma	0,049 kN-m
Static permissible moment, Mb	0,049 kN-m
Static permissible moment, Mc	0,069 kN-m