

SMSF 30G NB

Linear bushing

TYPE: Shaft guidance systems, Linear bushing, With flange, Circular type, Type SMF, Asian standard, Corrosion resistance, Plastic cage (NB)

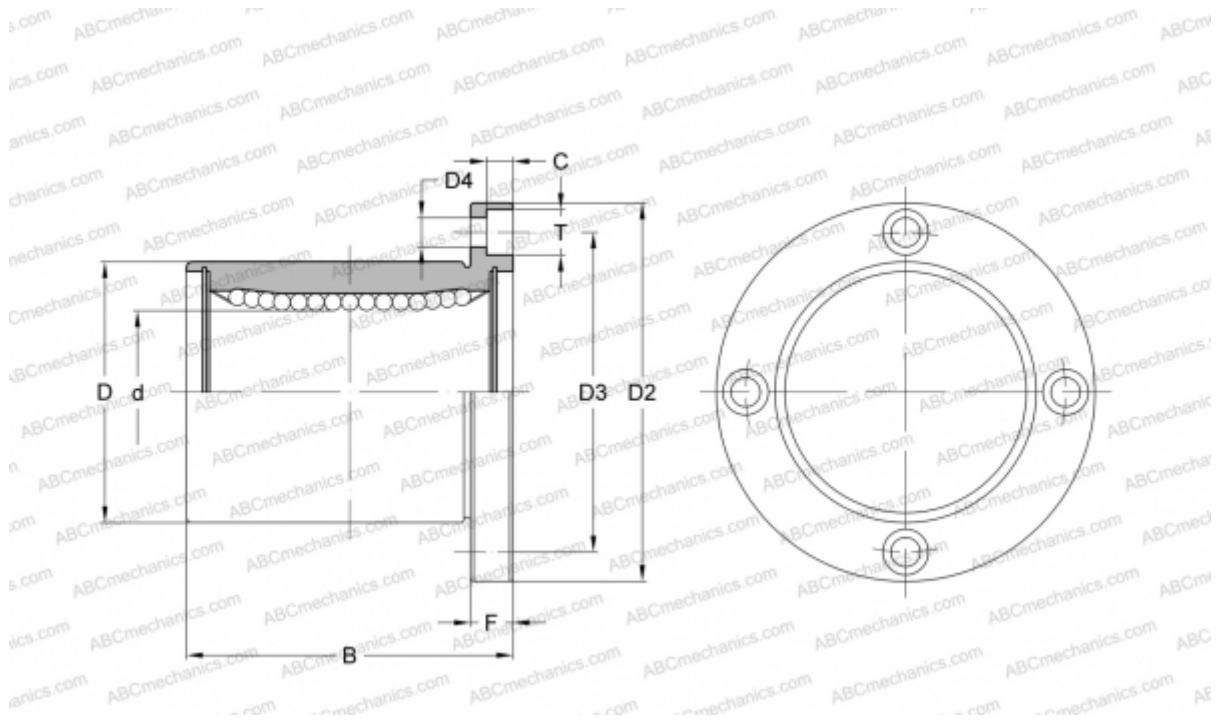

Technical specification

DIMENSIONS, MM

d	30,000
D	45,000
B	64,000
D2	74,000
D3	60,000
D4	6,600
T	11,000
C	6,100
F	10

WEIGHT, KG 0,470

MANUFACTURER [NB](#)