

SAH25FL NSK

Linear guides

TYPE: Monorail guidance systems, Recirculating balls, High vertical load carrying capacity type, Self-aligning type, Flanged type, Low, Ball slide length - standard, Mounting bolt hole, Low noise, smooth operation type, Interchangeable part

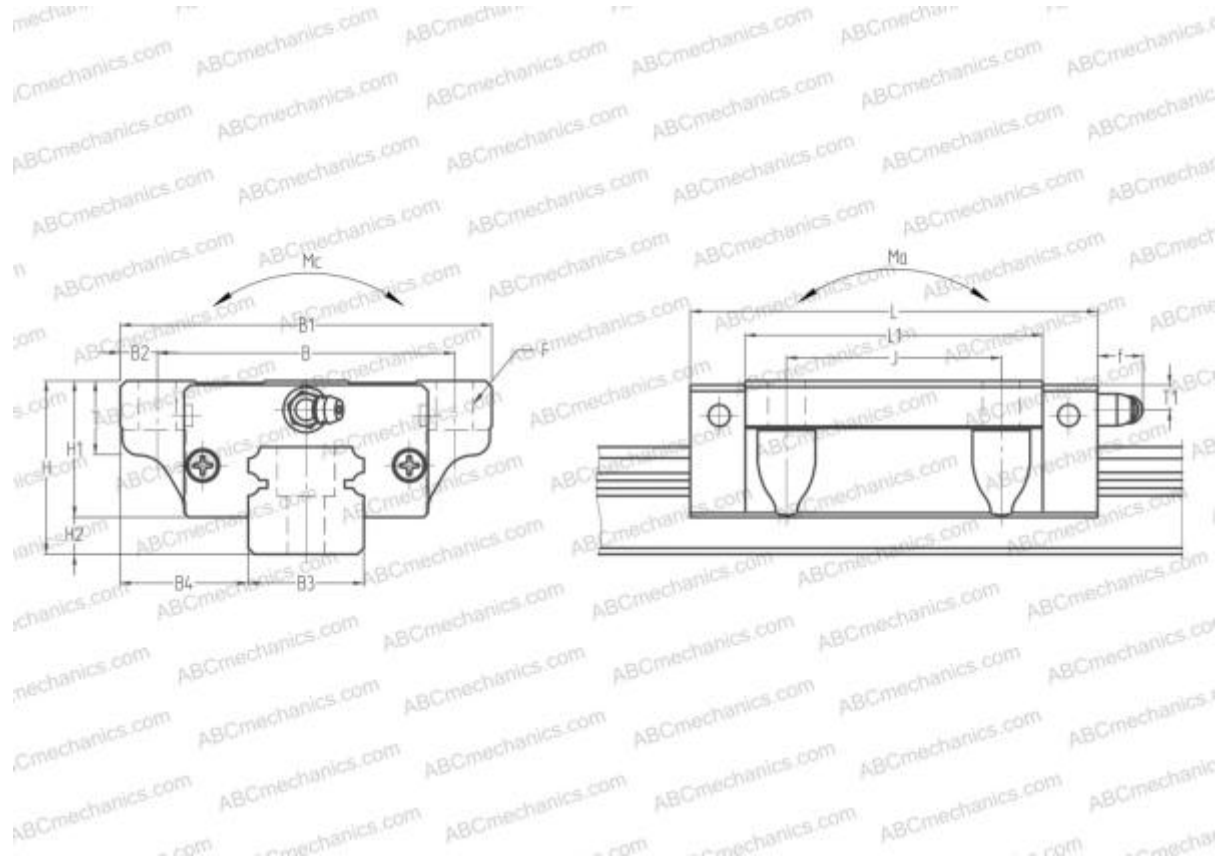

Technical specification

DIMENSIONS, MM

B1	70,000
H	36,000
L	79,000
B	57,000
J	45,000
L1	58,000
D2	11,500
B2	6,500
B3	23,000
B4	23,500
H1	29,000
H2	7,000
T	11,000
T1	6,000
f	11,000

DIMENSIONS, MM

F	7x10
---	------

SLIDE WEIGHT	0,630
---------------------	-------

MANUFACTURER	NSK
---------------------	---------------------

CALCULATION DATA

Basic dynamic load rating, C	19,800 kN
Basic static load rating, Co	36,000 kN
Static permissible moment, Ma	0,284 kN-m
Static permissible moment, Mb	0,284 kN-m
Static permissible moment, Mc	0,333 kN-m