

SAH20HL NSK

Linear guides

TYPE: Monorail guidance systems, Recirculating balls, High vertical load carrying capacity type, Self-aligning type, Flanged type, Low, Ball slide length - long, Mounting bolt hole, Low noise, smooth operation type, Interchangeable part

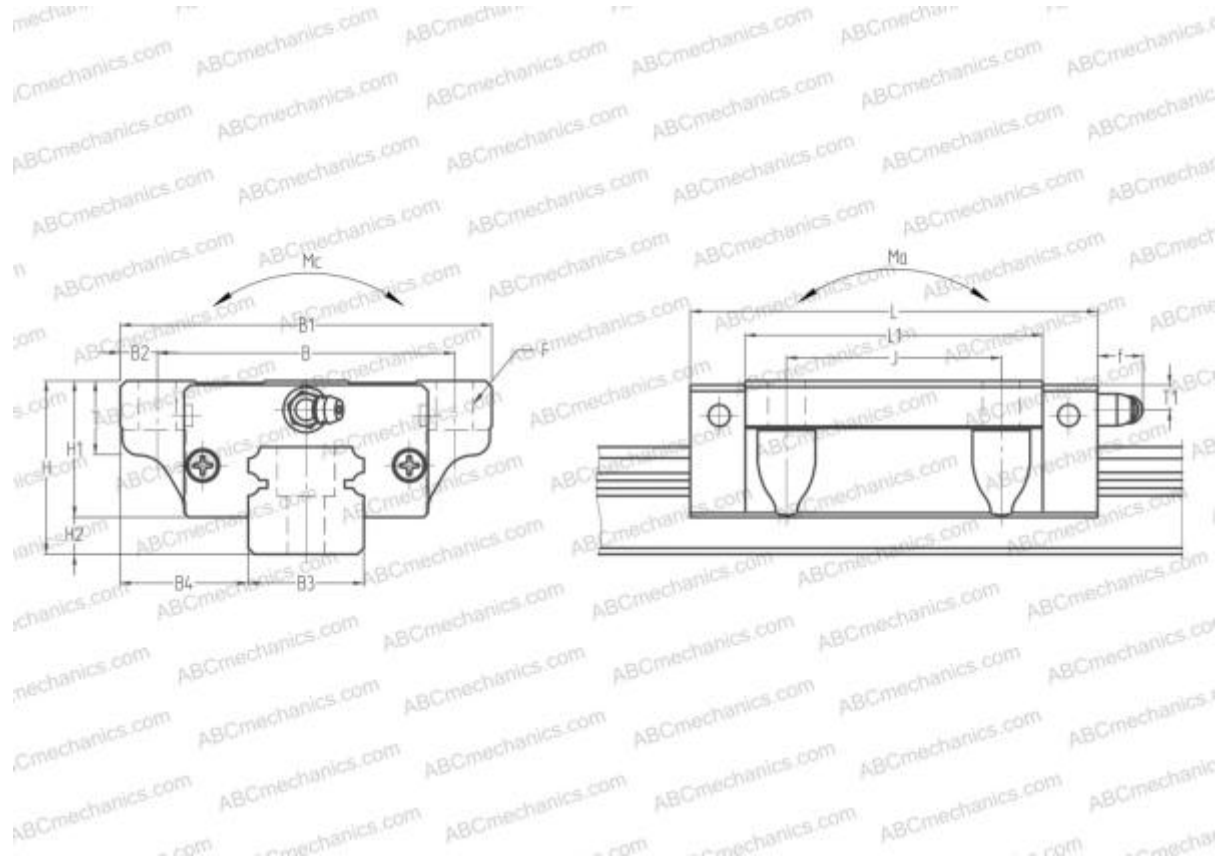

Technical specification

DIMENSIONS, MM

B1	63,000
H	30,000
L	91,800
B	53,000
J	40,000
L1	72,000
D2	10,000
B2	5,000
B3	20,000
B4	21,500
H1	25,000
H2	5,000
T	10,000
T1	5,000
f	11,000

DIMENSIONS, MM

F	6x10
---	------

SLIDE WEIGHT	0,650
---------------------	-------

MANUFACTURER	NSK
---------------------	---------------------

CALCULATION DATA

Basic dynamic load rating, C	17,500 kN
Basic static load rating, Co	37,000 kN
Static permissible moment, Ma	0,323 kN-m
Static permissible moment, Mb	0,323 kN-m
Static permissible moment, Mc	0,284 kN-m