

## SS25JL ABC

Linear guides

TYPE: Monorail guidance systems, Recirculating balls, High vertical load carrying capacity type, Self-aligning type, Flanged type, Low, Ball slide length - short, Mounting tap, Compact, Low noise, smooth operation type

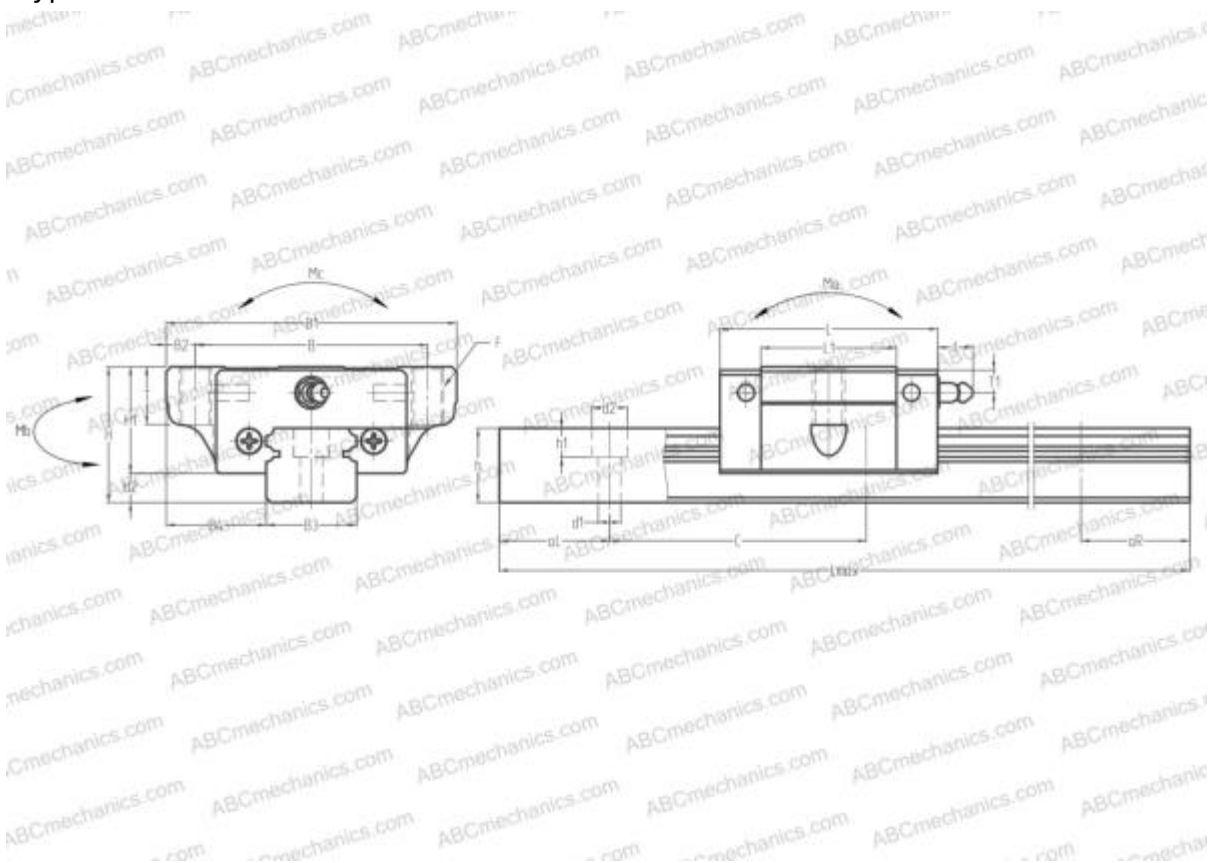

### Technical specification

#### DIMENSIONS, MM

B1	73,000
H	33,000
L	59,600
B	60,000
L1	38,000
D2	11,500
B2	6,500
B3	23,000
B4	25,000
H1	26,000
H2	7,000
T	11,000
T1	7,000
f	11,000
C	60,000

#### DIMENSIONS, MM

d1	7,000
d2	11,000
h	18,000
h1	9,000
L max	3960,000
aL	20,000
aR	20,000
F	M8x1.25x12

#### WEIGHT

Slide weight	0,440
Rail weight	3,100

#### MANUFACTURER

[ABC](#)

#### INTERCHANGE

NSK	<a href="#">SS25JL</a>
-----	------------------------

