

## SS30JL ABC

Linear guides

TYPE: Monorail guidance systems, Recirculating balls, High vertical load carrying capacity type, Self-aligning type, Flanged type, Low, Ball slide length - short, Mounting tap, Compact, Low noise, smooth operation type

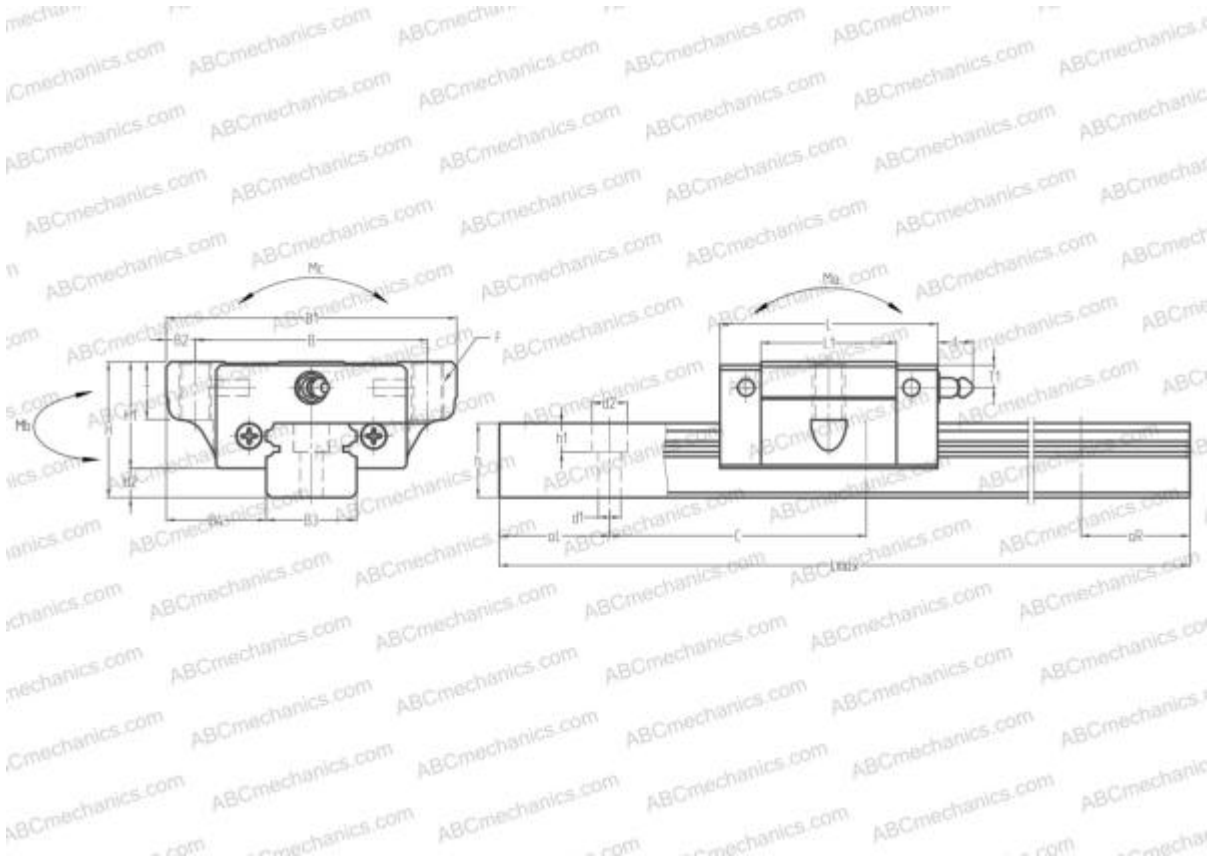

### Technical specification

#### DIMENSIONS, MM

B1	90,000
H	42,000
L	67,400
B	72,000
L1	42,000
D2	14,000
B2	9,000
B3	28,000
B4	31,000
H1	33,000
H2	9,000
T	11,000
T1	8,000
f	11,000
C	80,000

#### DIMENSIONS, MM

d1	7,000
d2	11,000
h	23,000
h1	9,000
L max	4000,000
aL	20,000
aR	20,000
F	M10x1.5x18

#### WEIGHT

Slide weight	0,760
Rail weight	4,800

#### MANUFACTURER

[ABC](#)

#### INTERCHANGE

NSK	<a href="#">SS30JL</a>
-----	------------------------

