

## SAS25KL NSK

Linear guides

TYPE: Monorail guidance systems, Recirculating balls, High vertical load carrying capacity type, Self-aligning type, Flanged type, Low, Ball slide length - short, Mounting bolt hole, Compact, Low noise, smooth operation type, Interchangeable part

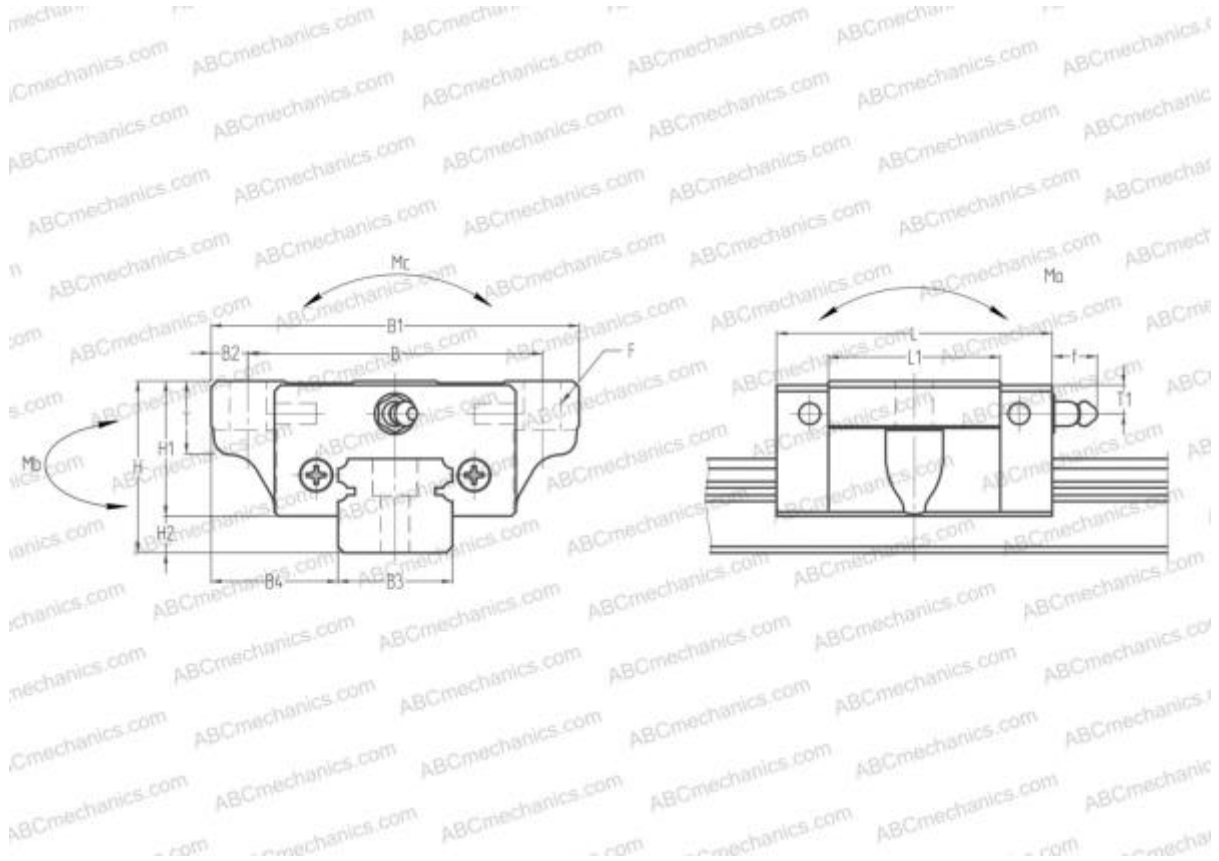

### Technical specification

#### DIMENSIONS, MM

B1	73,000
H	9,000
L	59,600
B	60,000
L1	38,000
D2	11,500
B2	6,500
B3	23,000
B4	25,000
H1	26,000
H2	7,000
T	11,000
T1	7,000
f	11,000
F	7x10

#### SLIDE WEIGHT

0,440

#### MANUFACTURER

[NSK](#)

#### CALCULATION DATA

Basic dynamic load rating, C	9,750 kN
Basic static load rating, Co	16,600 kN
Static permissible moment, Ma	0,059 kN-m
Static permissible moment, Mb	0,059 kN-m
Static permissible moment, Mc	0,127 kN-m