

LAW17EL NSK

Linear guides

TYPE: Monorail guidance systems, Recirculating balls, High vertical load carrying capacity type, High moment load carrying type (Wide rail type), Flanged type, Low, Ball slide length - standard, Mounting tap, Interchangeable part

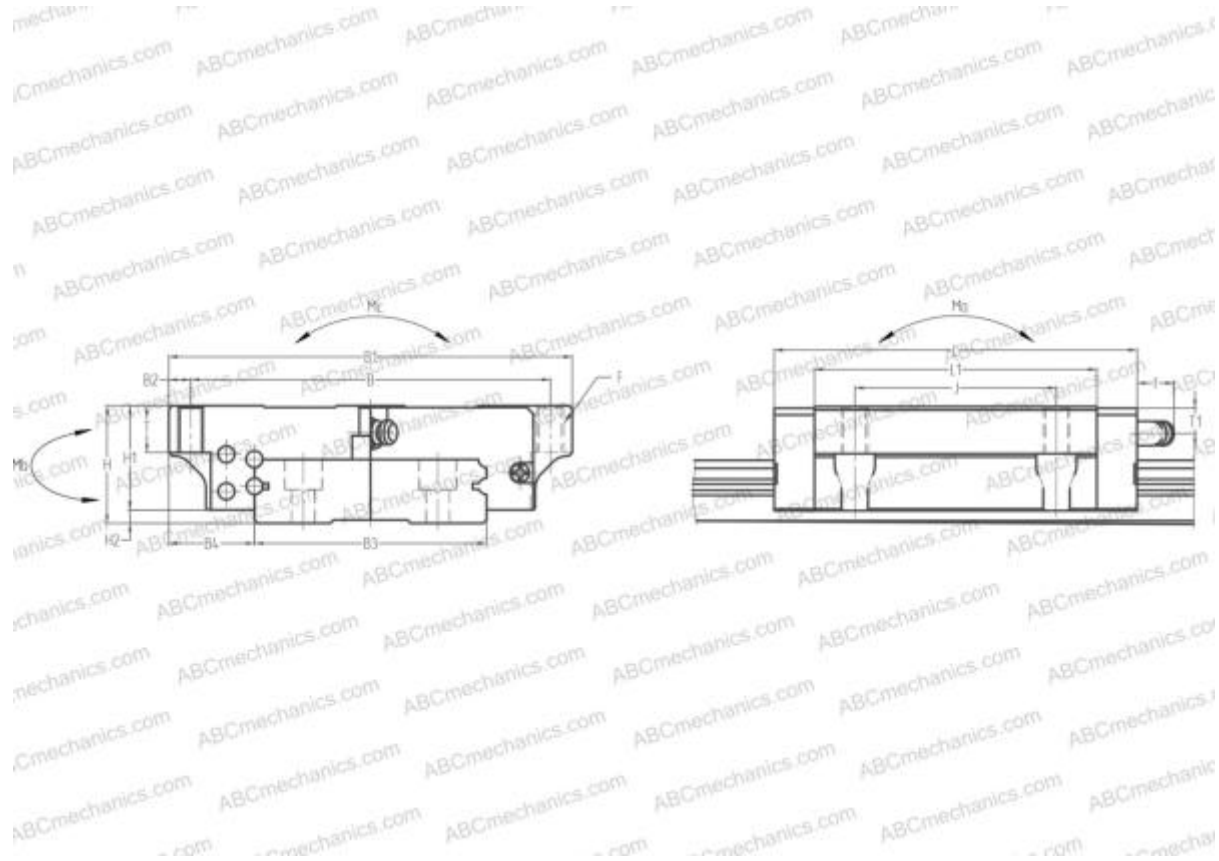

Technical specification

DIMENSIONS, MM

B1	60,000
H	17,000
L	51,400
B	53,000
J	26,000
L1	35,000
B2	3,500
B3	33,000
B4	13,500
H1	14,500
H2	2,500
T	6,000
T1	4,000
f	3,000
F	M4x0.7x6

SLIDE WEIGHT

0,200

MANUFACTURER

[NSK](#)

CALCULATION DATA

Basic dynamic load rating, C	4,200 kN
Basic static load rating, Co	9,100 kN
Static permissible moment, Ma	0,036 kN-m
Static permissible moment, Mb	0,033 kN-m
Static permissible moment, Mc	0,114 kN-m