

LAW35EL NSK

Linear guides

TYPE: Monorail guidance systems, Recirculating balls, High vertical load carrying capacity type, High moment load carrying type (Wide rail type), Flanged type, Low, Ball slide length - standard, Mounting tap, Interchangeable part

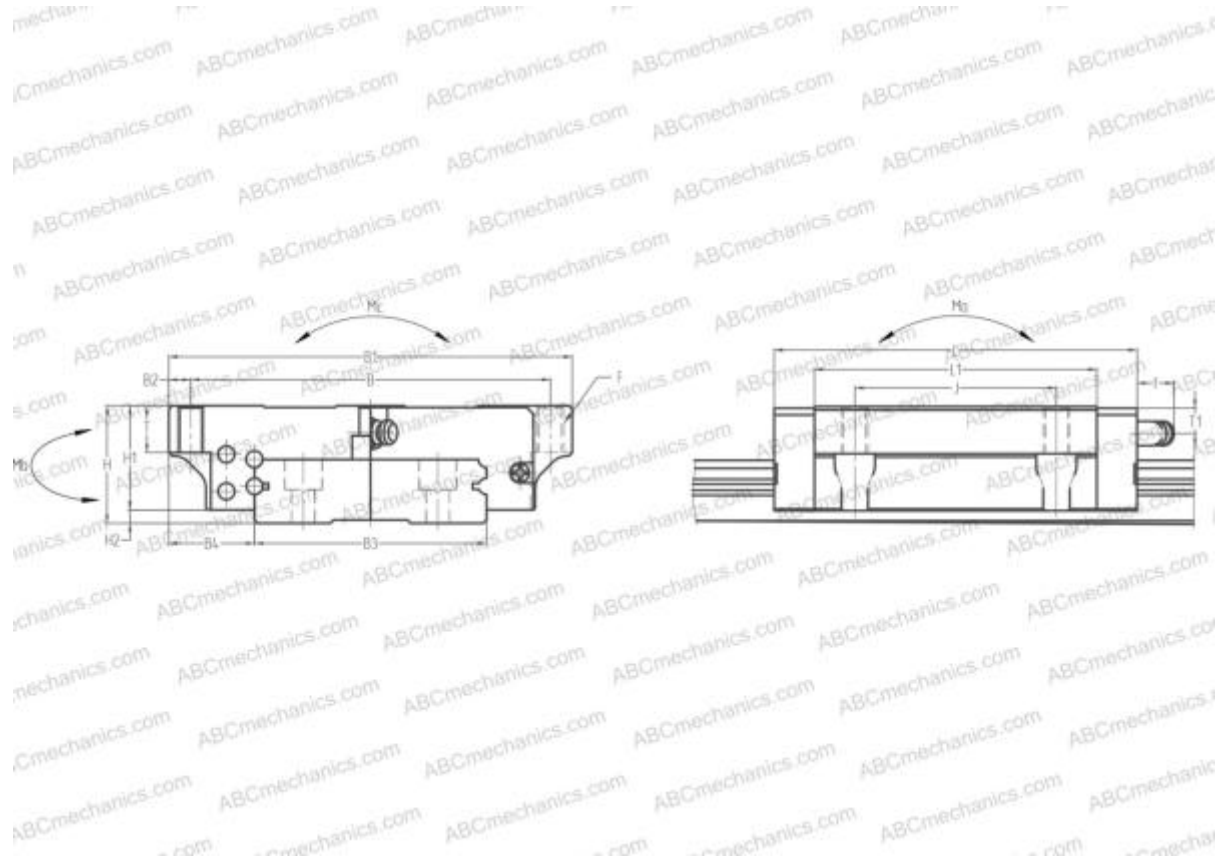

Technical specification

DIMENSIONS, MM

B1	120,000
H	35,000
L	108,000
B	107,000
J	60,000
L1	84,000
B2	6,500
B3	69,000
B4	25,500
H1	31,000
H2	4,000
T	14,000
T1	8,000
f	11,000
F	M8x1.25x14

SLIDE WEIGHT

1,500

MANUFACTURER

[NSK](#)

CALCULATION DATA

Basic dynamic load rating, C	25,700 kN
Basic static load rating, Co	52,500 kN
Static permissible moment, Ma	0,535 kN-m
Static permissible moment, Mb	0,525 kN-m
Static permissible moment, Mc	1,470 kN-m