

LY30GL ABC

Linear guides

TYPE: Monorail guidance systems, Recirculating balls, Four directional iso-load carrying type, High rigidity type, Flanged type, Low, Ball slide length - long, Mounting tap

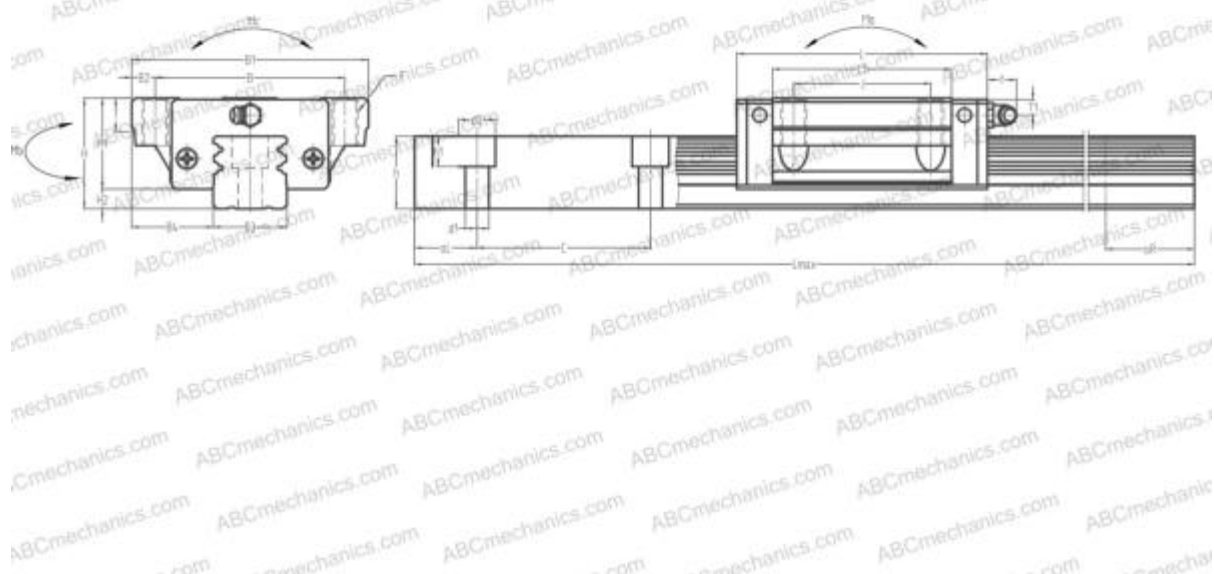

Technical specification

DIMENSIONS, MM

B1	90,000
H	42,000
L	115,200
B	72,000
J	52,000
L1	88,000
B2	9,000
B3	28,000
B4	31,000
H1	34,500
H2	7,500
T	11,000
T1	6,500
f	11,000
C	80,000

DIMENSIONS, MM

d1	9,000
d2	14,000
h	27,500
h1	12,000
L max	3000,000
aL	20,000
aR	20,000
F	M10x1.5x18

WEIGHT

Slide weight	1,300
Rail weight	5,800

MANUFACTURER

[ABC](#)

INTERCHANGE

NSK	LY30GL
THK	HSR30LA



INTERCHANGE

IKO	LWHTG30
HIWIN	LGW30HA
STAR	1653-7

