

LWHG25 IKO

Linear guides

TYPE: Monorail guidance systems, Recirculating balls, Four directional iso-load carrying type, High rigidity type, Flanged type, Low, Ball slide length - long, Mounting bolt hole

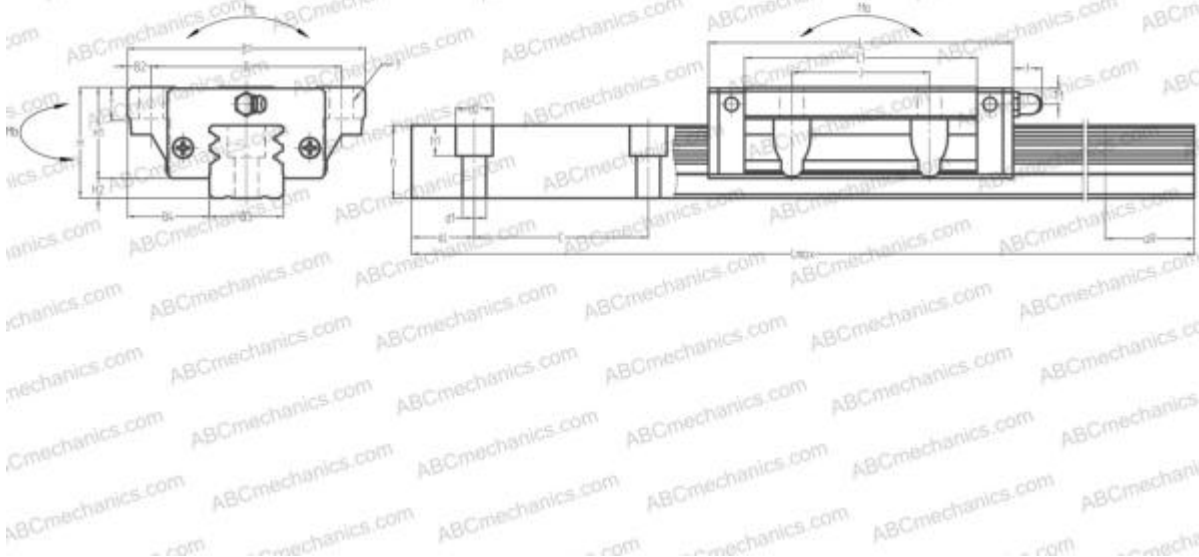

Technical specification

DIMENSIONS, MM

B1	70,000
H	36,000
L	102,800
B	57,000
J	45,000
L1	80,000
B2	6,500
B3	23,000
B4	23,500
H1	30,500
H2	5,500
T	11,000
T1	6,000
f	11,000
C	60,000

DIMENSIONS, MM

d1	7,000
d2	11,000
h	22,500
h1	9,000
L max	2200,000
aL	20,000
aR	20,000
F	7x10

WEIGHT

Slide weight	0,830
Rail weight	3,900

MANUFACTURER

[IKO](#)

INTERCHANGE

ABC	LY25HL
NSK	LY25HL

INTERCHANGE

THK	HSR25LB
HIWIN	LGW25HB
STAR	1653-2