

LWHG35 IKO

Linear guides

TYPE: Monorail guidance systems, Recirculating balls, Four directional iso-load carrying type, High rigidity type, Flanged type, Low, Ball slide length - long, Mounting bolt hole

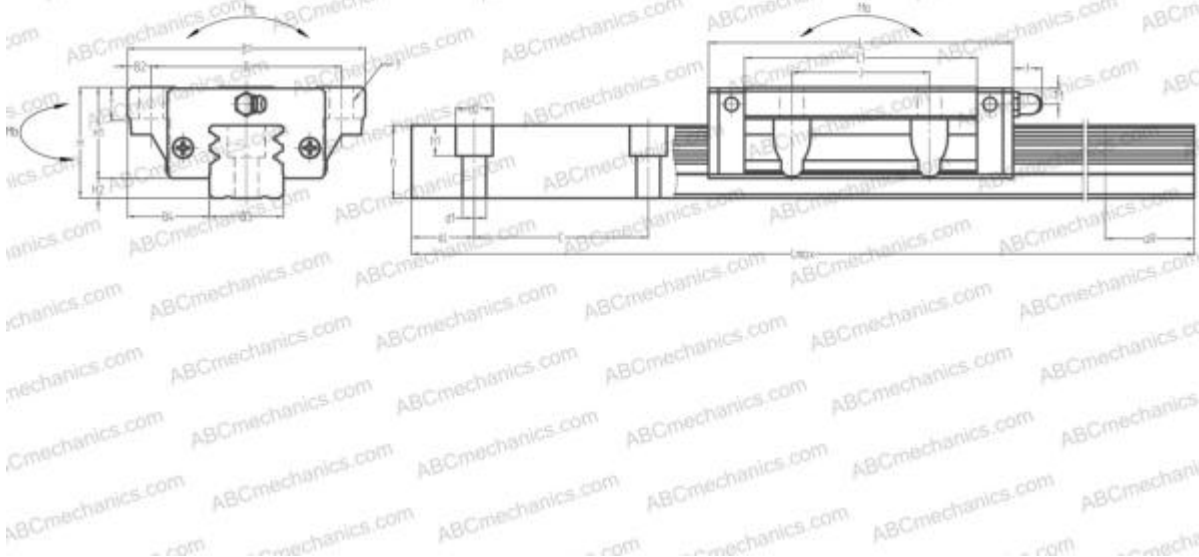

Technical specification

DIMENSIONS, MM

B1	100,000
H	48,000
L	133,400
B	82,000
J	62,000
L1	103,000
B2	9,000
B3	34,000
B4	33,000
H1	40,500
H2	7,500
T	12,000
T1	8,000
f	11,000
C	80,000

DIMENSIONS, MM

d1	9,000
d2	14,000
h	31,000
h1	12,000
L max	3000,000
aL	20,000
aR	20,000
F	9x13

WEIGHT

Slide weight	2,000
Rail weight	7,900

MANUFACTURER

[IKO](#)

INTERCHANGE

ABC	LY35HL
NSK	LY35HL

INTERCHANGE

THK	HSR35LB
HIWIN	LGW35HB
STAR	1653-3