

LWHG55 IKO

Linear guides

TYPE: Monorail guidance systems, Recirculating balls, Four directional iso-load carrying type, High rigidity type, Flanged type, Low, Ball slide length - long, Mounting bolt hole

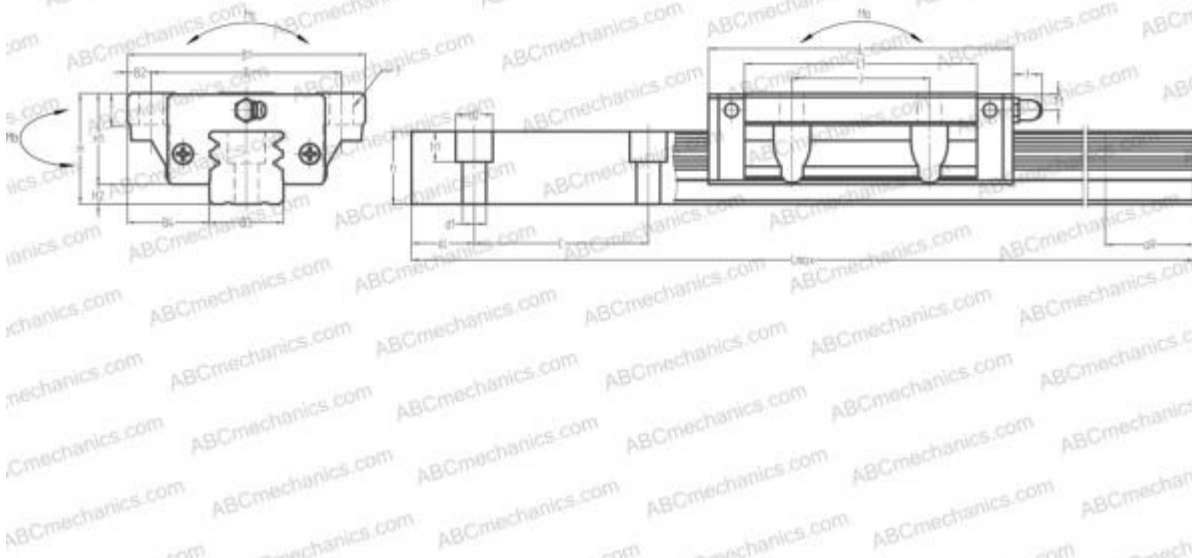

Technical specification

DIMENSIONS, MM

B1	140,000
H	70,000
L	200,000
B	116,000
J	95,000
L1	160,000
B2	12,000
B3	53,000
B4	43,500
H1	57,000
H2	13,000
T	14,000
T1	11,000
f	13,000
C	120,000

DIMENSIONS, MM

d1	16,000
d2	23,000
h	45,000
h1	20,000
L max	3000,000
aL	30,000
aR	30,000
F	14x17

WEIGHT

Slide weight	6,100
Rail weight	17,900

MANUFACTURER

[IKO](#)

INTERCHANGE

ABC	LY55HL
NSK	LY55HL

INTERCHANGE

THK	HSR55LB
HIWIN	LGW55HB
STAR	1653-5