

SMSK 13G NB

Linear bushing

TYPE: Shaft guidance systems, Linear bushing, With flange, Square type, Type SMK, Asian standard, Corrosion resistance, Plastic cage (NB)

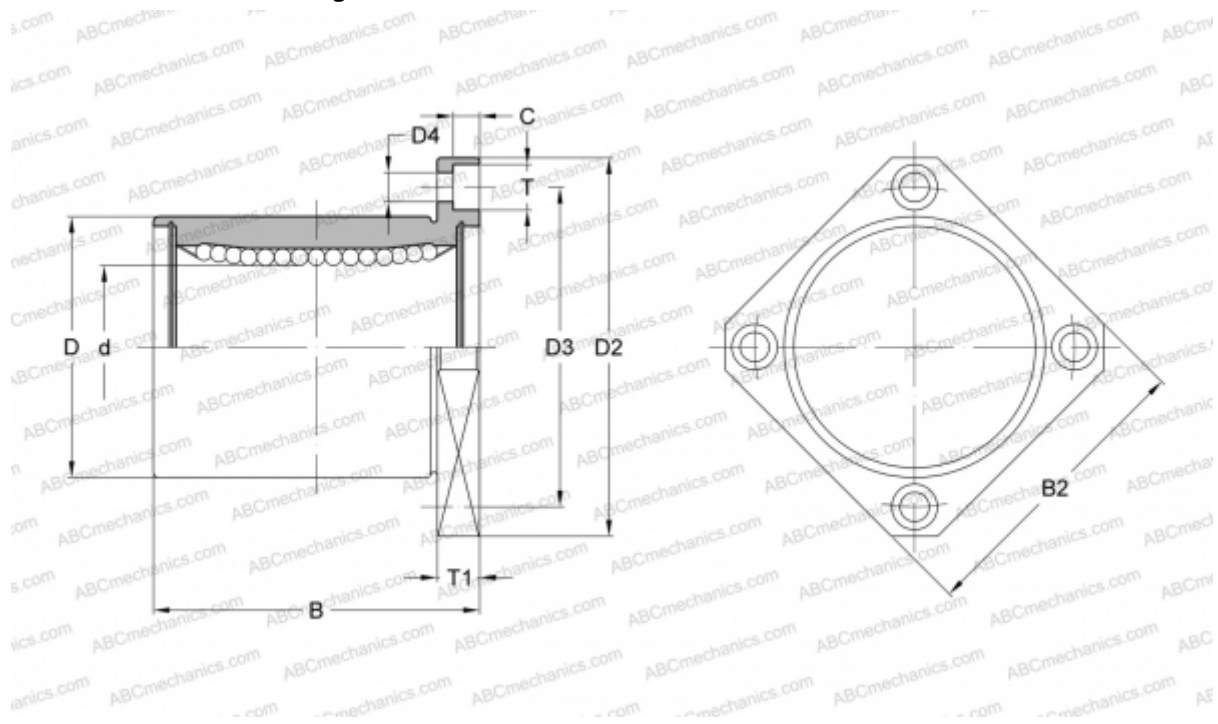

Technical specification

DIMENSIONS, MM

d	13,000
D	23,000
B	32,000
D2	43,000
D3	33,000
D4	4,500
B2	34,000
T	7,500
T1	6,000
C	4,100

WEIGHT, KG 0,072

MANUFACTURER [NB](#)