

## SMSK 20G NB

Linear bushing

TYPE: Shaft guidance systems, Linear bushing, With flange, Square type, Type SMK, Asian standard, Corrosion resistance, Plastic cage (NB)

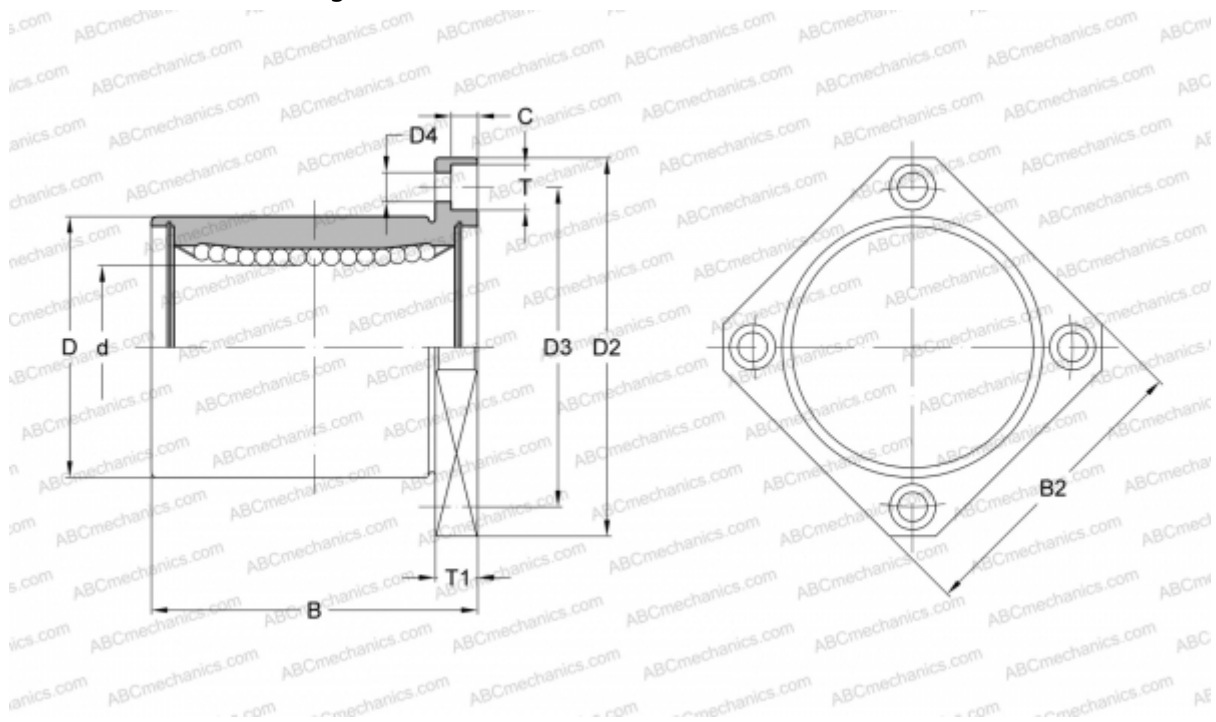

### Technical specification

#### DIMENSIONS, MM

d	20,000
D	32,000
B	42,000
D2	54,000
D3	43,000
D4	5,500
B2	42,000
T	9,000
T1	8,000
C	5,100

**WEIGHT, KG** 0,145

**MANUFACTURER** [NB](#)