

## SMST 13UU NB

Linear bushing

TYPE: Shaft guidance systems, Linear bushing, With flange, Oval type, Type SMT, Asian standard, Corrosion resistance, Stainless steel cage (NB)

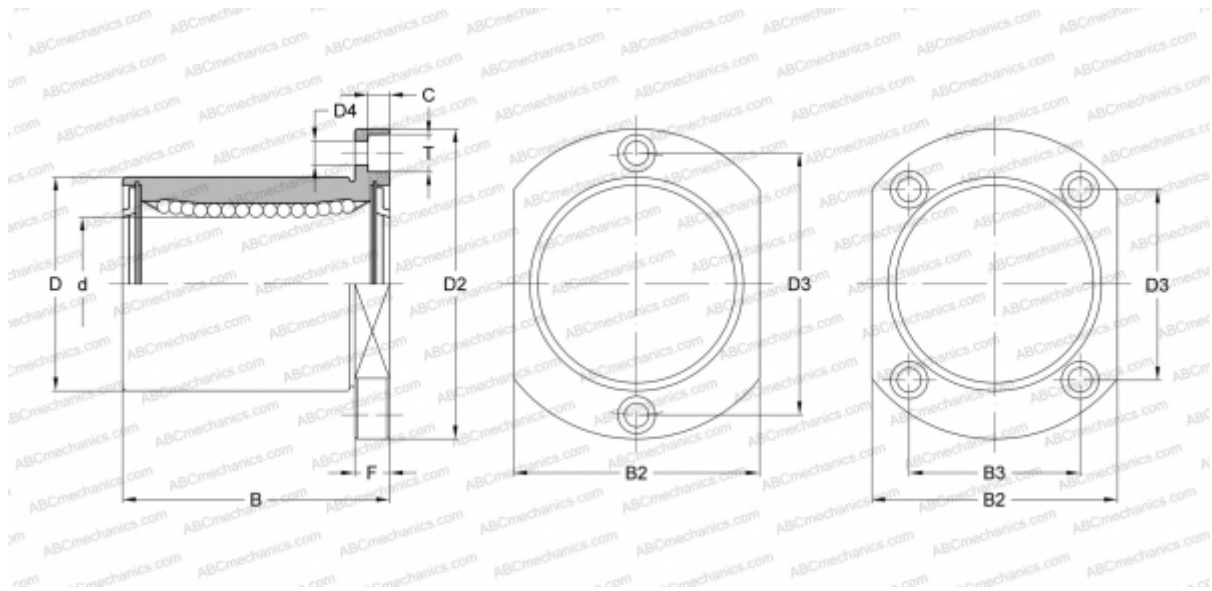

### Technical specification

#### DIMENSIONS, MM

d	13,000
D	23,000
B	32,000
D2	43,000
D3	33,000
D4	4,500
B2	29,000
T	7,500
C	4,100
F	6

**WEIGHT, KG** 0,081

**MANUFACTURER** [NB](#)