

SMSF 25UU-E NB

Linear bushing

TYPE: Shaft guidance systems, Linear bushing, Pilot flange location, Circular type, Type SMF..E, Asian standard, Corrosion resistance, Stainless steel cage (NB)

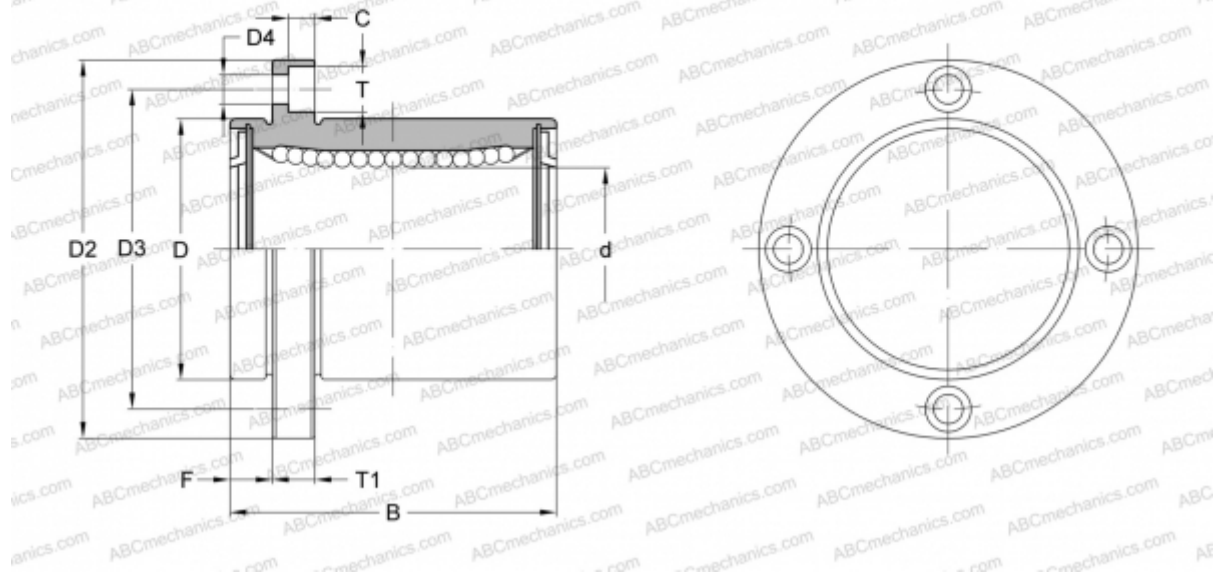

Technical specification

DIMENSIONS, MM

d	25,000
D	40,000
B	59,000
D2	62,000
D3	51,000
D4	5,500
T	9,000
T1	8,000
C	5,100
F	8

WEIGHT, KG 0,340

MANUFACTURER [NB](#)