

## SMK 6UU-E NB

Linear bushing

TYPE: Shaft guidance systems, Linear bushing, Pilot flange location, Square type, Type SMK..E, Asian standard, Steel cage (NB)

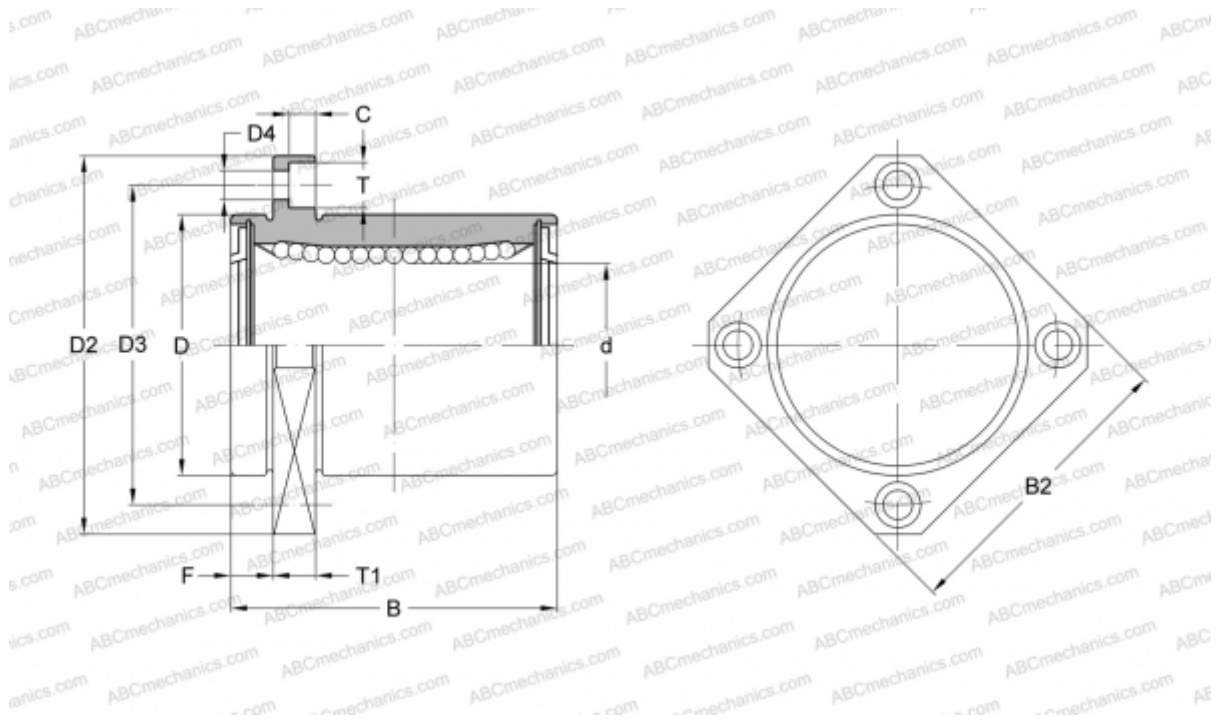

### Technical specification

#### DIMENSIONS, MM

d	6,000
D	12,000
B	19,000
D2	28,000
D3	20,000
D4	3,500
B2	22,000
T	6,000
T1	5,000
C	3,100
F	5

**WEIGHT, KG** 0,018

**MANUFACTURER** [NB](#)