

SMSK 8UU-E NB

Linear bushing

TYPE: Shaft guidance systems, Linear bushing, Pilot flange location, Square type, Type SMK..E, Asian standard, Corrosion resistance, Stainless steel cage (NB)

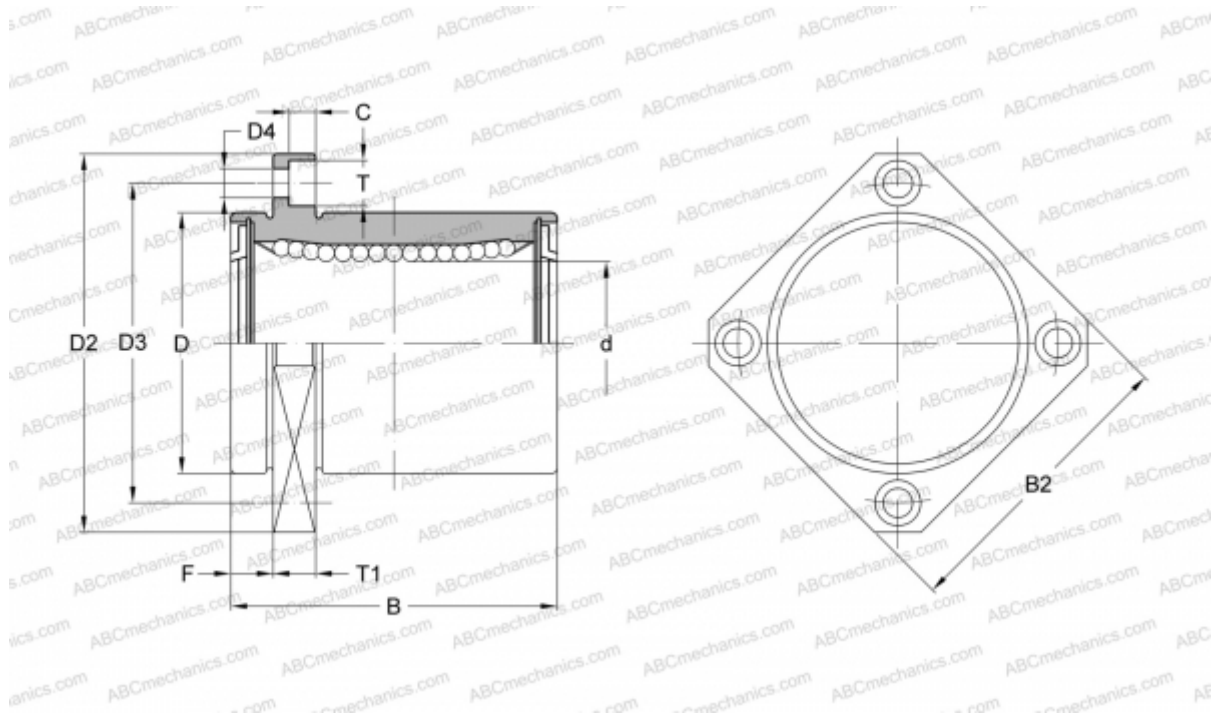

Technical specification

DIMENSIONS, MM

d	8,000
D	15,000
B	24,000
D2	32,000
D3	24,000
D4	3,500
B2	25,000
T	6,000
T1	5,000
C	3,100
F	5

WEIGHT, KG 0,029

MANUFACTURER [NB](#)