

SMF 35W NB

Linear bushing

TYPE: Shaft guidance systems, Linear bushing, With flange, Circular type, double length, Type SMF..W, Asian standard, Steel cage (NB)

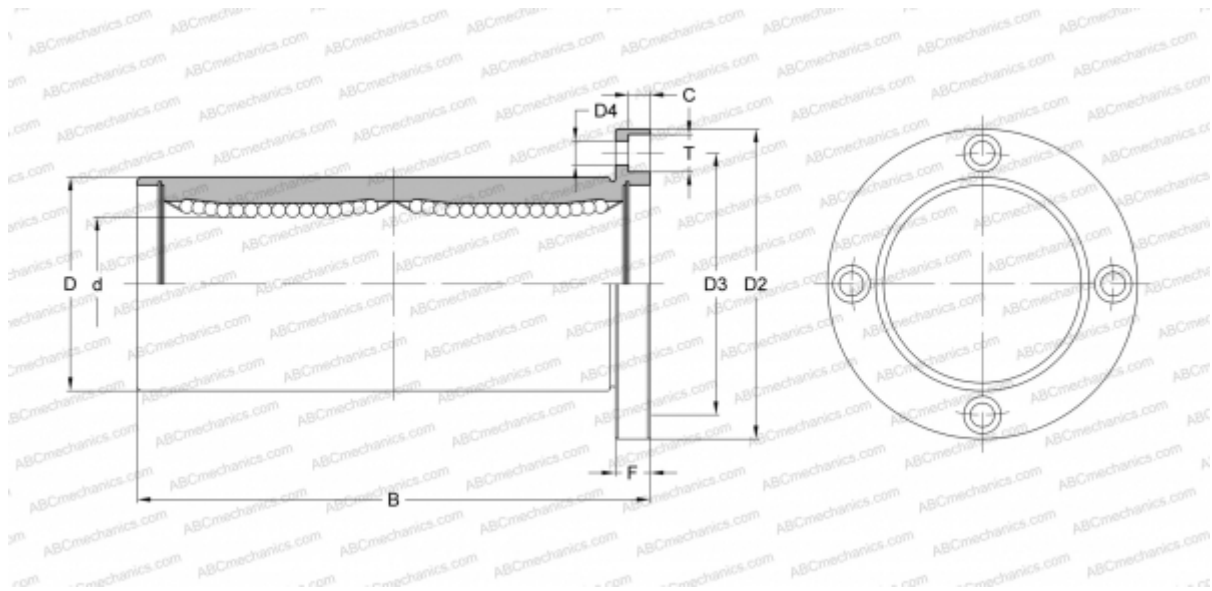

Technical specification

DIMENSIONS, MM

d	35,000
D	52,000
B	135,000
D2	82,000
D3	67,000
D4	6,600
T	11,000
C	6,100
F	10

WEIGHT, KG 1,020

MANUFACTURER [NB](#)