

SMF 40W NB

Linear bushing

TYPE: Shaft guidance systems, Linear bushing, With flange, Circular type, double length, Type SMF..W, Asian standard, Steel cage (NB)

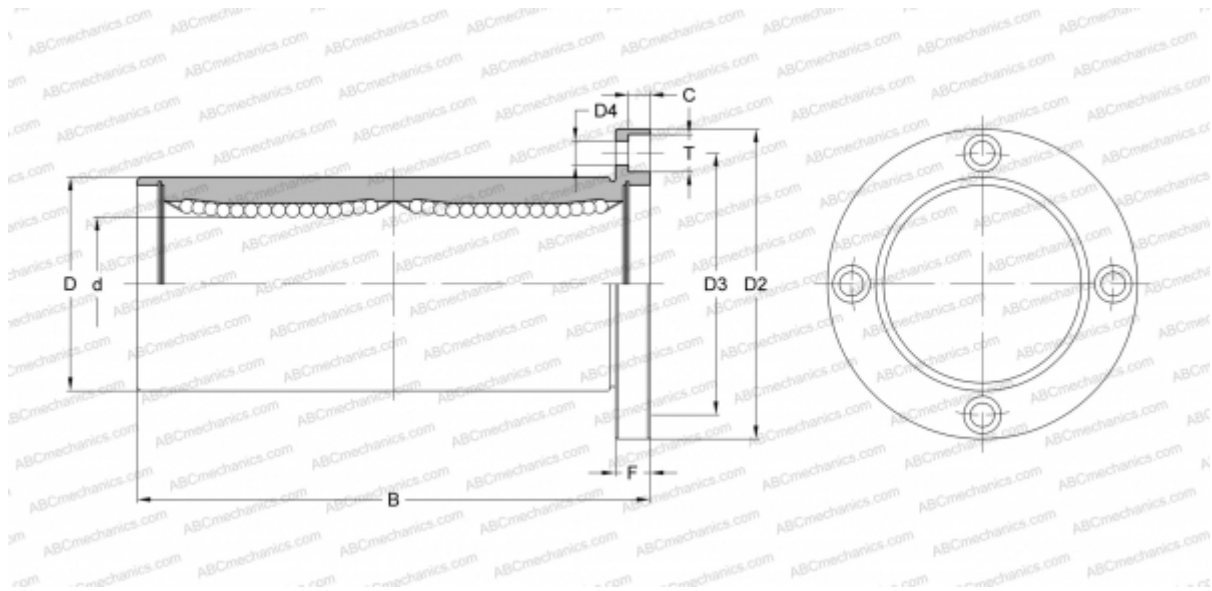

Technical specification

DIMENSIONS, MM

d	40,000
D	60,000
B	151,000
D2	96,000
D3	78,000
D4	9,000
T	14,000
C	8,100
F	13

WEIGHT, KG 1,570

MANUFACTURER [NB](#)