

SMK 25W NB

Linear bushing

TYPE: Shaft guidance systems, Linear bushing, With flange, Square type, double length, Type SMK..W, Asian standard, Steel cage (NB)

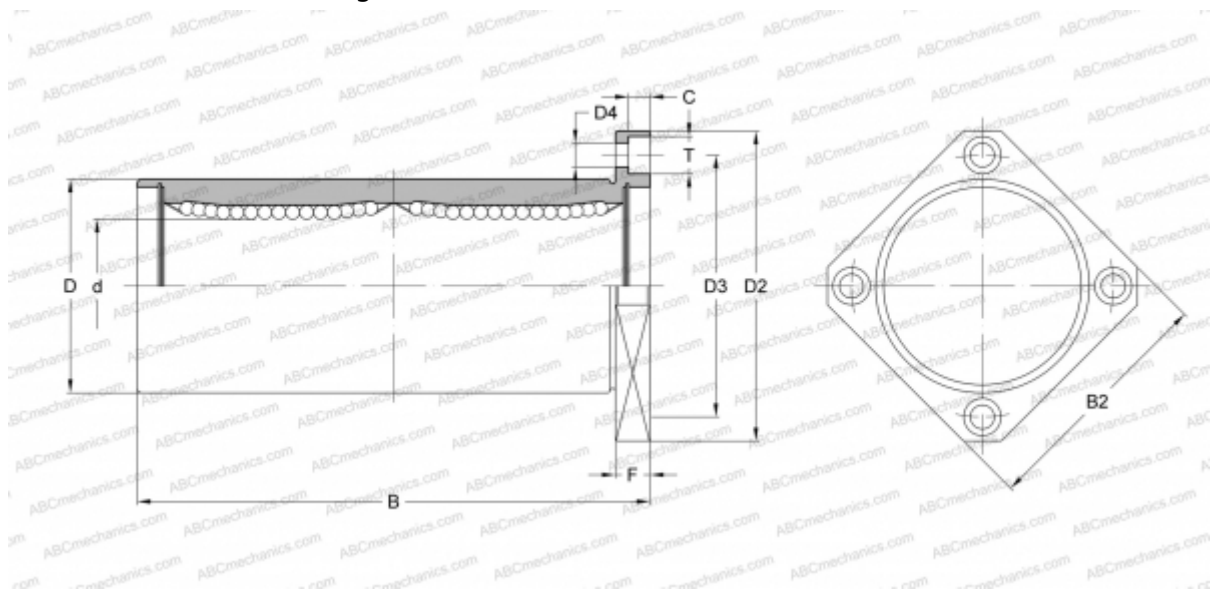

Technical specification

DIMENSIONS, MM

d	25,000
D	40,000
B	112,000
D2	62,000
D3	51,000
D4	5,500
T	9,000
C	5,100
F	8

WEIGHT, KG 0,500

MANUFACTURER [NB](#)