

## SMSK 6W NB

Linear bushing

TYPE: Shaft guidance systems, Linear bushing, With flange, Square type, double length, Type SMK..W, Asian standard, Corrosion resistance, Stainless steel cage (NB)

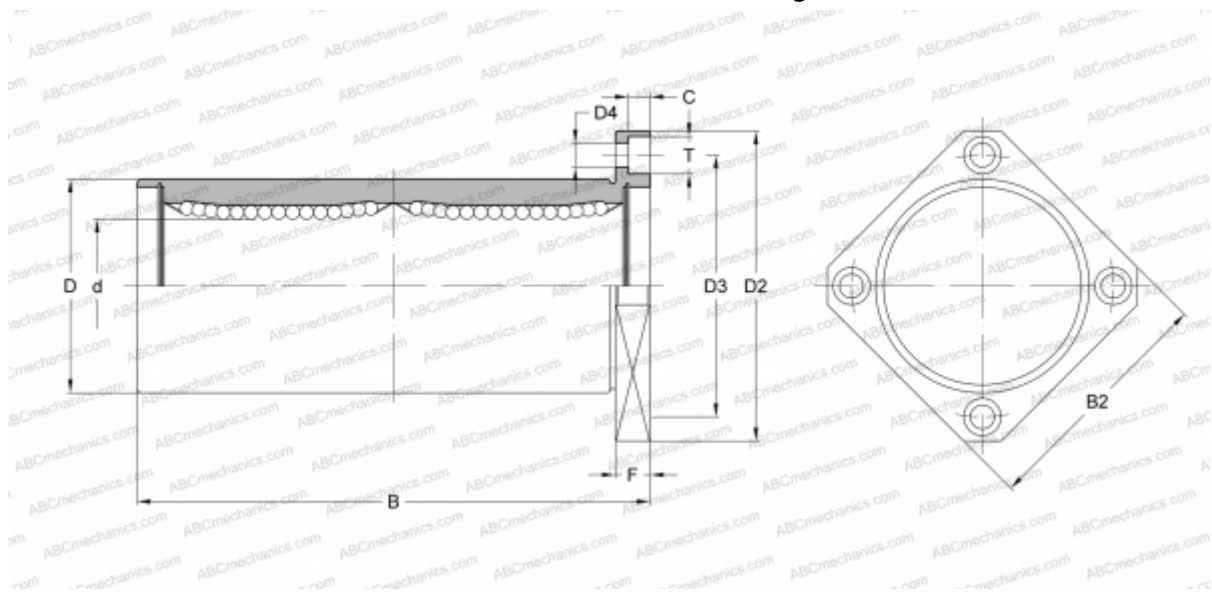

### Technical specification

#### DIMENSIONS, MM

d	6,000
D	12,000
B	35,000
D2	28,000
D3	20,000
D4	3,500
T	6,000
C	3,100
F	5

**WEIGHT, KG** 0,025

**MANUFACTURER** [NB](#)