

SMSK 35W NB

Linear bushing

TYPE: Shaft guidance systems, Linear bushing, With flange, Square type, double length, Type SMK..W, Asian standard, Corrosion resistance, Stainless steel cage (NB)

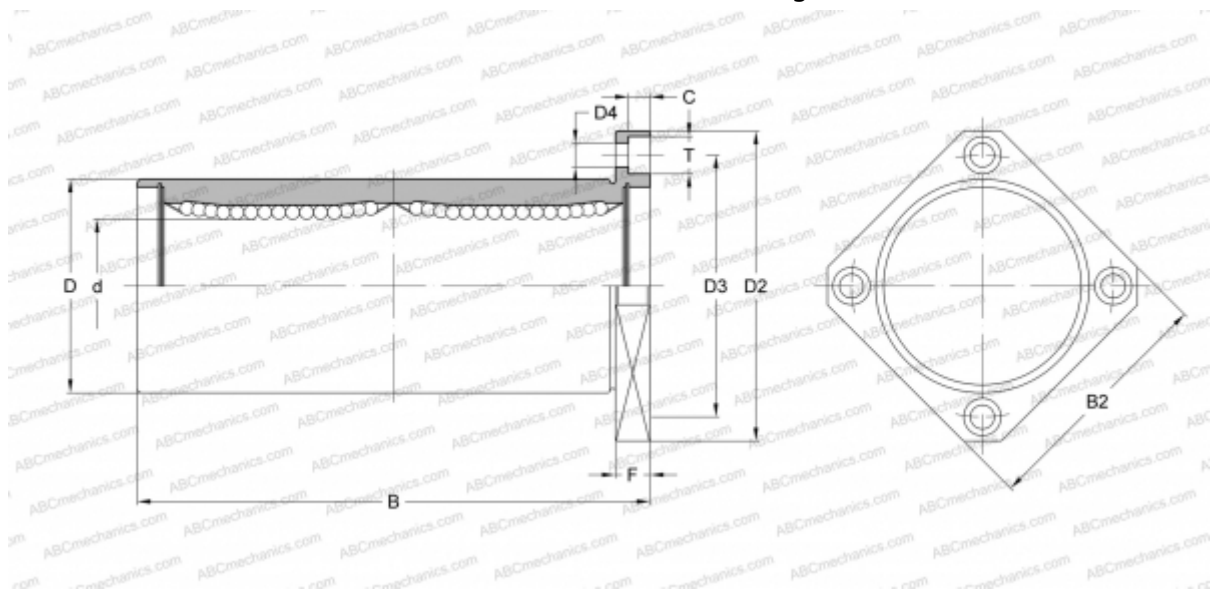

Technical specification

DIMENSIONS, MM

d	35,000
D	52,000
B	135,000
D2	82,000
D3	67,000
D4	6,600
T	11,000
C	6,100
F	10

WEIGHT, KG 0,930

MANUFACTURER [NB](#)