

SMSK 8GW NB

Linear bushing

TYPE: Shaft guidance systems, Linear bushing, With flange, Square type, double length, Type SMK..W, Asian standard, Corrosion resistance, Plastic cage (NB)

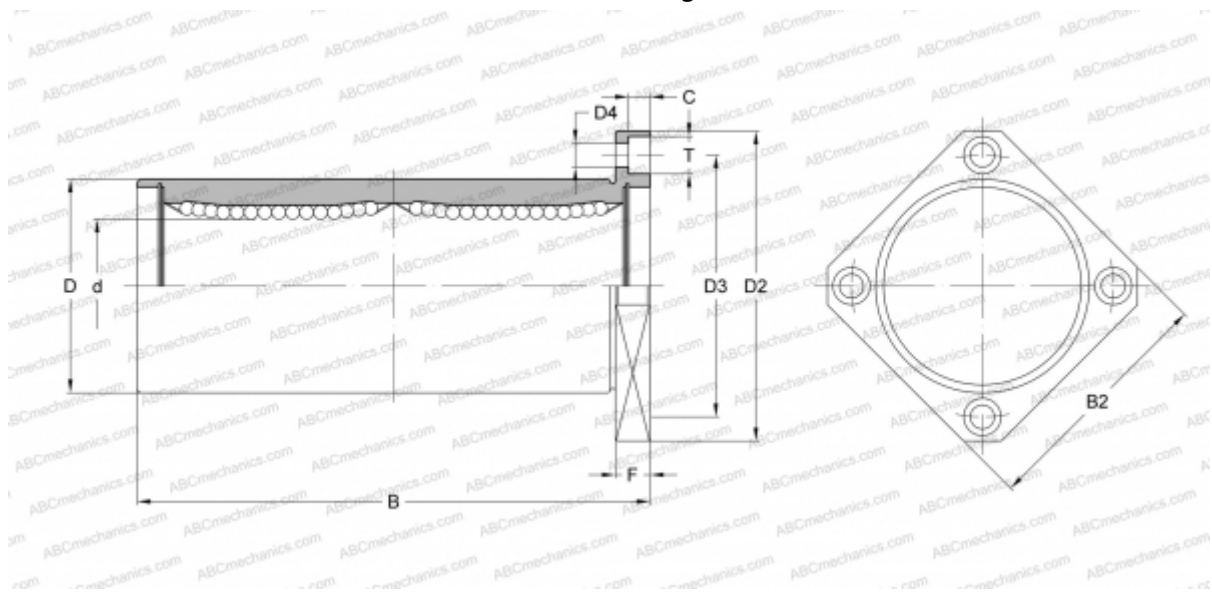

Technical specification

DIMENSIONS, MM

d	8,000
D	15,000
B	45,000
D2	32,000
D3	24,000
D4	3,500
T	6,000
C	3,100
F	5

WEIGHT, KG 0,043

MANUFACTURER [NB](#)