

SMSK 60GW NB

Linear bushing

TYPE: Shaft guidance systems, Linear bushing, With flange, Square type, double length, Type SMK..W, Asian standard, Corrosion resistance, Plastic cage (NB)

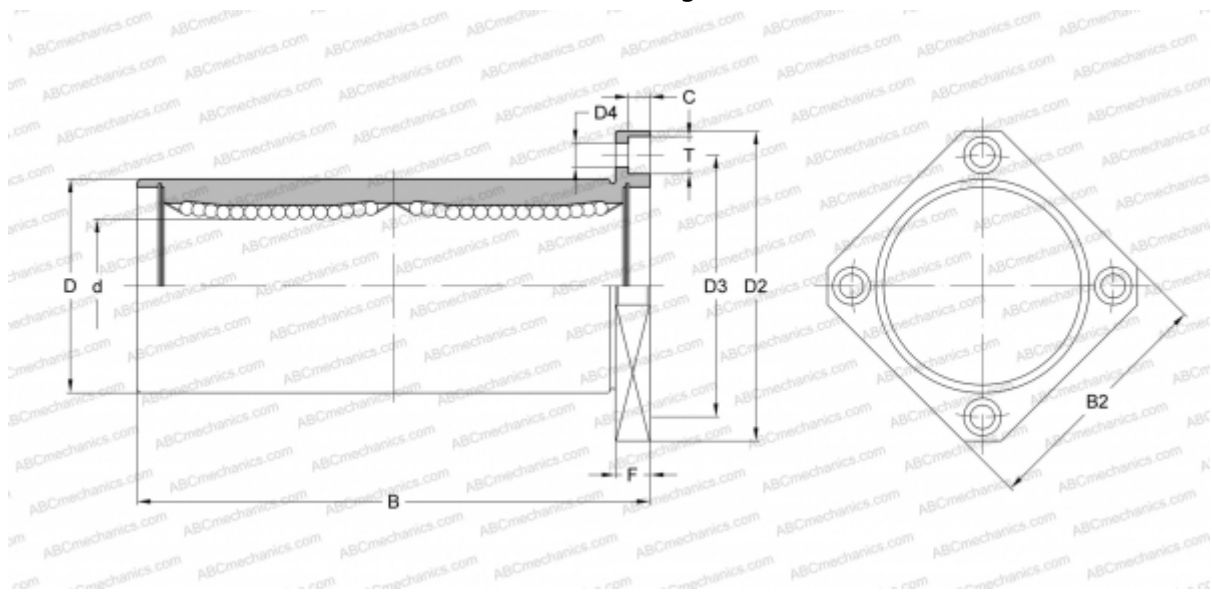

Technical specification

DIMENSIONS, MM

d	60,000
D	90,000
B	209,000
D2	134,000
D3	112,000
D4	11,000
T	17,000
C	11,100
F	18

WEIGHT, KG 4,060

MANUFACTURER [NB](#)